

# Plena Voice Alarm System



Security Systems

en | Installation and User Instructions  
Voice Alarm System

**BOSCH**



## Important Safeguards

Prior to installing or operating this product, always read the Important Safety Instructions which are available as a separate document (9922 141 7014x). These instructions are supplied together with all equipment that can be connected to the mains.

## Important Notices

When using routers, keypads or more than one call station, configure the controller using the supplied software.

Use shielded cable (Cat-5) between the routers and the controller. Do not connect the shield to both the controller and the router!

The factory default setting of the Plena Voice Alarm Controller is as follows:

- Stand-alone unit configured for an ISO 60849 compliant system when used with a spare power amplifier from the Plena range and compliant wiring and loudspeakers.
- One channel system.
- Supervision on for:
  - Loudspeaker lines  
(90 seconds interval, 15% accuracy)
  - Main and spare power amplifier
  - Short to ground (“Ground short”)
  - Mains and battery power
  - EMG mic
  - Memory
- For the remote controls to function, all firmware must be version 2.0 or higher. The factory-installed firmware is indicated on every component of the voice alarm system (LBB1990/00, LBB1992/00, LBB1956/00, LBB1995/00, LBB1996/00, LBB1997/00, LBB1998/00, LBB1999/00). If a label is not present, the firmware version is 1.x.

Thank you for choosing a Bosch Security Systems product.

# Table of Contents

<b>Important Safeguards .....</b>	<b>3</b>
<b>Important Notices .....</b>	<b>4</b>
<b>Table of Contents .....</b>	<b>5</b>
<b>Section 1 - Introduction .....</b>	<b>9</b>
<b>1. About this manual .....</b>	<b>10</b>
1.1 Purpose .....	10
1.2 Digital document .....	10
1.3 Intended audience .....	10
1.4 Related documentation .....	10
1.5 Alerts .....	10
1.6 Signs .....	10
1.7 Conversion tables .....	11
<b>2. System Overview .....</b>	<b>12</b>
2.1 Voice Alarm System .....	12
2.2 Application types .....	12
2.3 Application areas .....	12
2.4 Plena .....	12
2.5 Voice alarm controller .....	12
2.6 Voice alarm router .....	13
2.7 Call station .....	14
<b>3. Application examples .....</b>	<b>15</b>
3.1 Schools .....	15
3.2 Swimming pool .....	17
3.3 Shopping mall .....	19
3.4 Hotel .....	21
<b>4. Calls and priorities .....</b>	<b>23</b>
4.1 Introduction .....	23
4.2 Priority .....	23
4.3 Mergeable messages .....	23
4.4 Business call .....	23
4.5 Emergency call .....	23
<b>Section 2 - Equipment .....</b>	<b>25</b>
<b>5. LBB1990/00 Voice Alarm Controller .....</b>	<b>26</b>
5.1 Controls, connectors and indicators .....	26
5.2 Installation .....	29
5.3 External connections .....	29
5.4 Technical data .....	41
<b>6. LBB1992/00 Voice Alarm Router .....</b>	<b>44</b>
6.1 Controls, connectors and indicators .....	44
6.2 Installation .....	46
6.3 External connections .....	46
6.4 Technical data .....	48
<b>7. LBB1956/00 Call Station .....</b>	<b>49</b>
7.1 Controls, connectors and indicators .....	49
7.2 External connections .....	50
7.3 Technical data .....	51

<b>8. LBB1957/00 Call Station Keypad</b>	<b>52</b>
8.1 Controls, connectors and indicators	52
8.2 Installation	53
8.3 Technical data	53
<b>9. LBB1996/00 Voice Alarm Remote Control</b>	<b>54</b>
9.1 Controls, connectors and indicators	54
9.2 Installation	56
9.3 External connections	56
9.4 Technical data	57
<b>10. LBB1998/00 Voice Alarm Remote Control Kit</b>	<b>58</b>
10.1 Introduction	58
10.2 Overview	58
10.3 Installation	58
10.4 External connections	59
10.5 Technical data	59
<b>11. LBB1997/00 Remote Control Extension</b>	<b>60</b>
11.1 Controls, connectors and indicators	60
11.2 Installation	61
11.3 External connections	61
11.4 Technical data	61
<b>12. LBB1999/00 Remote Control Extension Kit</b>	<b>62</b>
12.1 Introduction	62
12.2 Overview	62
12.3 Installation	62
12.4 External connections	63
12.5 Technical data	63
<b>13. LBB1995/00 Fireman's Panel</b>	<b>64</b>
13.1 Controls, connectors and indicators	64
13.2 External connections	66
13.3 Technical data	66
<b>14. End of line detection</b>	<b>67</b>
14.1 Introduction	67
14.2 Overview	67
14.3 Installation	67
14.4 Technical data	70
<b>15. Dummy load</b>	<b>71</b>
15.1 Introduction	71
15.2 Set the jumper JP1 on the Dummy load	71
15.3 Installation	71
<b>Section 3 - Configuration</b>	<b>73</b>
<b>16. Introduction</b>	<b>74</b>
<b>17. System settings</b>	<b>75</b>
17.1 Introduction	75
17.2 Monitor	75
17.3 APR mode	75
17.4 Supervision	76
17.5 1 channel and 2 channel operation	76

<b>18. Supervision</b>	<b>77</b>
18.1 Introduction	77
18.2 Processor reset	77
18.3 Network	77
18.4 Power amplifiers	77
18.5 Ground short	78
18.6 Emergency trigger inputs	78
18.7 Mains power	78
18.8 Battery	78
18.9 Message supervision	78
18.10 Emergency microphone	78
18.11 Line supervision	78
<b>19. Voice alarm controller</b>	<b>80</b>
19.1 VOX configuration	80
<b>20. Voice alarm router</b>	<b>81</b>
20.1 Introduction	81
20.2 Router ID	81
20.3 Termination switch	81
<b>21. Call station</b>	<b>82</b>
21.1 Introduction	82
21.2 Call station ID	82
21.3 Sensitivity	82
21.4 Speech filter	82
21.5 Termination	82
<b>22. Remote control</b>	<b>83</b>
22.1 Introduction	83
22.2 Remote control ID	83
22.3 Monitor	83
22.4 Termination switch	83
<b>23. Remote control extension</b>	<b>83</b>
23.1 Introduction	83
23.2 Remote control extension ID	83
23.3 Termination switch	83
<b>Section 4 - Operation</b>	<b>85</b>
<b>24. Switch on and off</b>	<b>86</b>
24.1 Voice alarm controller	86
24.2 Voice alarm router	86
24.3 Calibration	86
<b>25. Background music</b>	<b>87</b>
25.1 Introduction	87
25.2 Select BGM source	87
25.3 Select zones	87
<b>26. Business calls</b>	<b>89</b>
26.1 Introduction	89
26.2 Select zones	89
<b>27. Emergency state</b>	<b>91</b>
27.1 Introduction	91
27.2 Enter the emergency state	91

27.3 Acknowledge the emergency state .....	91
27.4 Exit the emergency state .....	92
27.5 Distribute live speech .....	92
<b>28. Fault state .....</b>	<b>95</b>
28.1 Introduction .....	95
28.2 Acknowledge the fault state .....	95
28.3 Reset the fault state .....	95
28.4 Fault indicators .....	95
<b>Glossary.....</b>	<b>99</b>
<b>Product Index.....</b>	<b>101</b>
<b>Emergency Sound Systems .....</b>	<b>103</b>

## Section 1 - Introduction

# 1 About this manual

## 1.1 Purpose

The purpose of the Installation and User Instructions is to provide information that is required to install, configure and operate a Plena Voice Alarm System.

## 1.2 Digital document

The Installation and User Instructions are also available as a digital document in the Adobe Portable Document Format (PDF). All references to pages, figures, tables, etc. in this digital document contain hyperlinks to the referenced location.

## 1.3 Intended audience

The Installation and User Instructions are intended for installers and users of an extensive Plena Voice Alarm System. Installers and users of a basic Plena Voice Alarm System (i.e. a system that is operated, configured and operated without a PC) should refer to the Basic System Manual (see section 1.4).

## 1.4 Related documentation

The following related documents are available:

- Plena Voice Alarm System Basic System Manual (9922 141 1036x).
- Plena Voice Alarm System Configuration Software Manual (9922 141 1038x).

## 1.5 Alerts

In this manual, four types of alerts are used. The alert type is closely related to the effect that may be caused when it is not observed. These alerts - from least severe effect to most severe effect - are:

- **Note**  
Alert containing additional information. Usually, not observing a note alert does not result in damage to the equipment or personal injuries.
- **Caution**  
The equipment can be damaged if the alert is not being observed.
- **Warning**  
Persons can be (severely) injured or the equipment can be seriously damaged if the alert is not being observed.
- **Danger**  
Not observing the alert can result in death.

## 1.6 Signs

Except for note alerts, the nature of the effect that can be caused when the alert is not observed, is indicated using a sign. For note alerts, the sign provides more information about the note itself. In this manual, the following signs are used in combination with alerts:

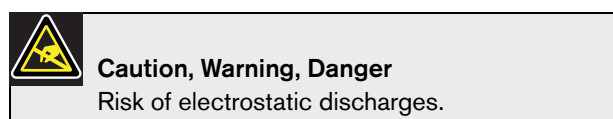
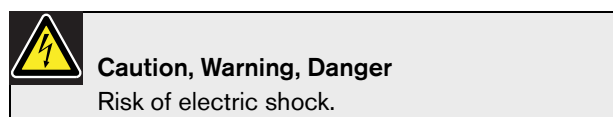
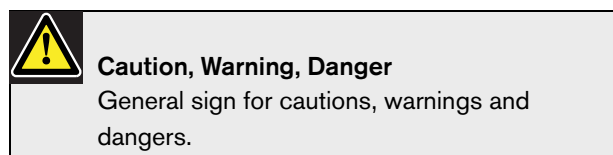
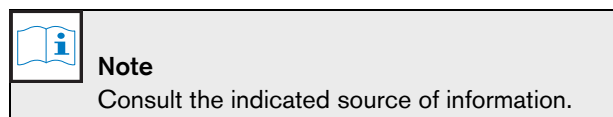
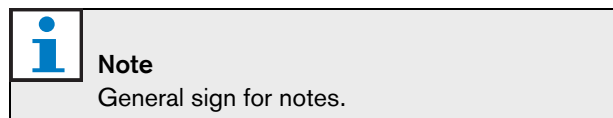

## 1.7 Conversion tables

In this manual, SI units are used to express lengths, masses, temperatures etc.. These can be converted to non-metric units using the information provided below.

*table 1.1: Conversion of units of length*

1 in =	25.4 mm	1 mm =	0.03937 in
1 in =	2.54 cm	1 cm =	0.3937 in
1 ft =	0.3048 m	1 m =	3.281 ft
1 mi =	1.609 km	1 km =	0.622 mi

*table 1.2: Conversion of units of mass*

1 lb =	0.4536 kg	1 kg =	2,2046 lb
--------	-----------	--------	-----------

*table 1.3: Conversion of units of pressure*

1 psi =	68.95 hPa	1 hPa =	0.0145 psi
---------	-----------	---------	------------



### Note

1 hPa = 1 mbar.

$$^{\circ}F = \frac{9}{5} \cdot ^{\circ}C + 32$$

$$^{\circ}C = \frac{5}{9} \cdot (^{\circ}F - 32)$$

## 2 System Overview

### 2.1 Voice Alarm System

The Plena Voice Alarm System is a public address and voice alarm system in which all the necessary features for compliance to evacuation standards such as IEC60849, NEN2575 and BS5839/8 are integrated.

### 2.2 Application types

Typically, the Plena Voice Alarm System is used to create small systems that must comply to evacuation standards, medium-sized systems in which one call channel is enough and large systems that consist of many small zones.

### 2.3 Application areas

The application areas of the Plena Voice Alarm System include:

- Supermarkets, shops
- Factories
- High-rise buildings
- Office buildings
- Schools
- Recreational facilities
- Hotels
- Small airports

### 2.4 Plena

The Plena Voice Alarm System is part of the Plena product range. Plena provides public address solutions for places where people gather to work, worship, trade or simply enjoy themselves. It is a family of system elements that are combined to create public address systems tailored for virtually any application. The range includes mixer, pre, system and power amplifiers, a source unit, digital message manager, feedback suppressor, conventional and PC call stations, an 'All-in-One' system and a voice alarm system. Each element is designed to complement all others thanks to matched acoustical, electrical and mechanical specifications.

### 2.4.1 Praesideo

It is possible to combine the Plena Voice Alarm System with a Praesideo digital public address and emergency sound system. When an audio output of Praesideo is connected to a VOX audio input of the Plena Voice Alarm System, calls that are made by the Praesideo system overrule the calls that are made with the Plena Voice Alarm System.

### 2.5 Voice alarm controller

#### 2.5.1 Introduction

The LBB1990/00 Voice Alarm Controller is the heart of the Plena Voice Alarm System. The voice alarm controller distributes emergency calls, business calls as well as background music (BGM) to up to 6 loudspeaker zones.



figure 2.1: Voice Alarm Controller



#### Note

When the voice alarm controller has been purchased in the Asian-Pacific Region, the emergency button has a different cover.

### 2.5.2 Hand-held microphone

The voice alarm controller is equipped with a hand-held microphone, which can be used to make emergency calls.

### 2.5.3 Internal power amplifier

The voice alarm controller has a 240 W internal power amplifier, which can be used in 1-channel or 2-channel mode. In the 1-channel mode, all calls and BGM are amplified by the internal power amplifier. If desired, an external power amplifier can be connected for spare switching. In the 2-channel mode, the BGM is amplified by the internal power amplifier, whereas the calls are amplified by an external power amplifier.

### 2.5.4 Internal message manager

The voice alarm controller has an internal message manager, which maps wave files (.wav) to messages that can be played by the Plena Voice Alarm System.

### 2.5.5 Supervision

All necessary supervision features for compliance to evacuation standards are integrated into the voice alarm controller. If supervision is enabled and a fault is detected, the voice alarm controller lights a LED on its front panel that indicates the cause of the fault.

### 2.5.6 Trigger inputs

The voice alarm controller has a terminal block to which 6 emergency (EMG) and 6 business trigger inputs can be connected. Third party systems can use the trigger inputs to start emergency and business calls in the Plena Voice Alarm System.

### 2.5.7 Remote control

With the LBB1996/00 Voice Alarm Remote Control, it is possible to control the voice alarm controller from another site. The remote control is also available as kit (LBB1998/00 Voice Alarm Remote Control Kit) for creating customized solutions. The maximum number of remote controls that can be connected to the voice alarm controller is 2. A special type of remote control is the LBB1995/00 Fireman's Panel.

## 2.6 Voice alarm router

### 2.6.1 Introduction

With the LBB1992/00 Voice Alarm Router, the number of loudspeaker zones and trigger inputs in the system can be increased.



figure 2.2: Voice alarm router

### 2.6.2 Loudspeaker zones

A voice alarm controller can serve and manage 6 loudspeaker zones. To increase the number of zones in the system, one or more LBB1992/00 Voice Alarm Routers can be connected to the voice alarm controller. Each router adds a maximum of 6 zones to the system. As the maximum number of voice alarm routers that can be connected in a system is 9, the maximum number of zones in a Plena Voice Alarm System is 60.

### 2.6.3 Trigger inputs

A voice alarm controller can manage 6 emergency (EMG) and 6 business trigger inputs. To increase the number of EMG and trigger inputs, one or more LBB1992/00 Voice Alarm Routers can be connected to the voice alarm controller. Each router adds a maximum of 6 EMG trigger inputs and 6 business trigger inputs to the system. As the maximum number of voice alarm routers that can be connected in a system is 9, the maximum number of EMG trigger inputs in a Plena Voice Alarm System is 60. The maximum number of business trigger inputs in a Plena Voice Alarm System is also 60.

## 2.6.4 External power amplifiers

The voice alarm router does not have an internal power amplifier. When the power that is supplied by the voice alarm controller is insufficient, to each voice alarm router two external power amplifiers can be connected. In a multi-router system, multiple power amplifiers can be connected to amplify calls and background music (BGM) or just for backup purposes.

## 2.6.5 Remote control

With the LBB1997/00 Voice Alarm Remote Control Extension, it is possible to control the voice alarm router from another location. The remote control extension is also available as a kit (LBB1999/00 Voice Alarm Remote Extension Kit) for creating customized solutions.

## 2.7 Call station

### 2.7.1 Introduction

The LBB1956/00 Call Station can be connected to the Plena Voice Alarm System to make business calls. The maximum number of call stations in a Plena Voice Alarm System is 8.



figure 2.3: Call Station

### 2.7.2 Buttons

Each call station has zone select buttons and a push-to-talk (PTT) button. The zone select buttons can be configured for selecting zones and zone groups in the system. To the PTT button, a pre- and post chime can be assigned that is played at the start or at the end of the business call.

### 2.7.3 Supervision

The call station is not supervised. For compliance to evacuation standards, the Plena Voice Alarm System disables the call station during emergency calls.

### 2.7.4 Keypad

Each voice alarm router can add 6 extra loudspeaker zones to the system. To be able to distribute calls to the extra zones, it is possible to connect LBB1957/00 to the call station. The maximum number of keypads that can be connected to a call station is 8.



figure 2.4: Call station keypad

## 3 Application examples

### 3.1 Schools

#### 3.1.1 Introduction

Schools are typical example of applications with a large number of zones each with a relatively low output power requirement per zone. The main priorities are speech intelligibility and compliance with IEC60849 standard (or equivalent). In addition to mandatory voice alarm functionality for evacuating staff and students, EVAC systems for schools should also include chime tones for notifying the start/finish of lessons, plus public address functionality for individually calling classrooms or public area. BGM is not essential. Since a classroom has a low ambient noise level, 1 loudspeaker is usually sufficient, keeping the total power requirement relatively low. Outside areas such as playgrounds and sports fields will require weatherproof horn loudspeakers.

#### 3.1.2 Summary of requirements

- Typically 20 to 60 zones (in high schools)
- Speech intelligibility is the main priority
- Low power requirement (1 loudspeaker) per classroom
- Fireman's panel by main entrance
- Call station in main office
- Additional public address functions such as chime tones desirable
- BGM in recreation areas is optional

#### 3.1.3 Solution for a 30-zone system

The Plena Voice Alarm System Controller handles message routing to 6 zones, the remaining 24 zones require four additional 6-zone routers. The office is equipped with a call station plus keypads for individually addressing zones, while a fireman's panel (with overall priority) is built in by the main entrance.

#### 3.1.4 Power requirements

The system controller features a built-in 240 W power amplifier, making it possible to drive up to 40 loudspeakers with a power handling capacity of 6 W each. This is sufficient for a medium-sized high school with 24 classrooms, 4 toilets/changing rooms, a staff meeting room and 2 offices, each requiring a single loudspeaker. The canteen, assembly hall, playing fields and corridors typically require more loudspeakers per zone. An additional Plena Power Amplifier is used as a spare amplifier.

#### 3.1.5 Layout

See figure 3.1, table 3.1 and table 3.2.

table 3.1: Zones

Zone	Description	Power
Z1-22	Classrooms	22 x 6 W
Z23	Toilets/changing rooms	4 x 6 W
Z24	Staff meeting room	1 x 6 W
Z25-26	Offices	2 x 6 W
Z27	Corridors	4 x 6 W
Z28	Assembly hall	2 x 6 W
Z29	Lunch canteen	2 x 6 W
Z30	Playing fields	1 x 10 W
<b>Total</b>		<b>232 W</b>

table 3.2: Units

Unit	Description	No.
LBB1990/00	Controller	1 x
LBB1992/00	Router	4 x
LBB1996/00	Remote control	1x
LBB1997/00	Remote control extension	4x
LBB1956/00	Call station	1x
LBB1957/00	Call station keypad	4x
LBB1935/00	Power Amplifier (240 W)	1x

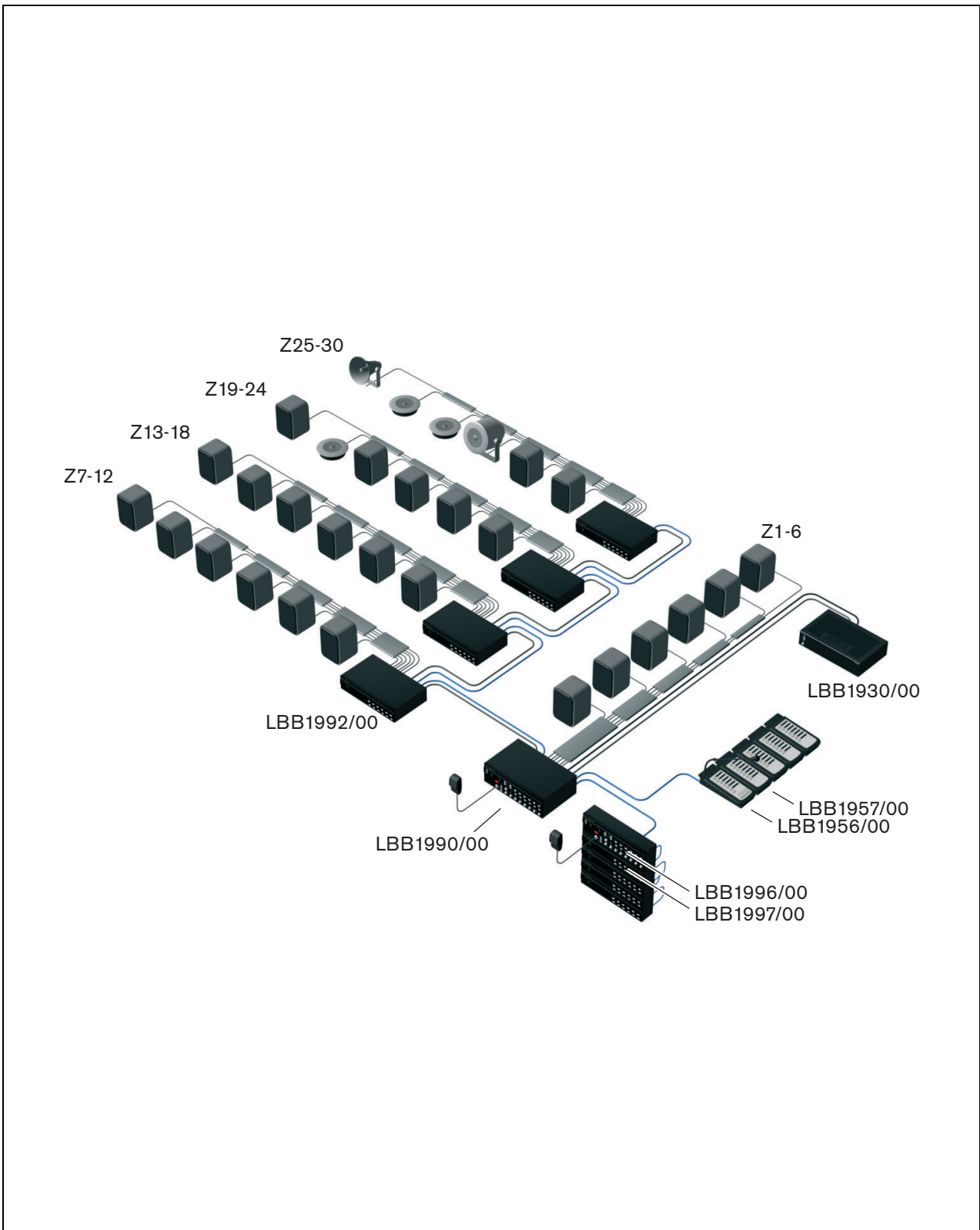

figure 3.1: Example of a school

## 3.2 Swimming pool

### 3.2.1 Introduction

Swimming pools and other indoor sports and recreational facilities are typical examples of smaller applications with few zones. The main priorities are excellent speech intelligibility and compliance with IEC60849 standard (and its national equivalents), although music in different areas is optional. An EVAC system for a swimming pool requires voice alarm functionality with public address functionality for regular announcements and background music (optional). To ensure that all visitors in the relatively noisy pool area hear emergency messages, the power output for that zone is relatively high. Other areas, such as the changing rooms and offices, have lower power requirements.

### 3.2.2 Summary of requirements

- Typically up to 6 zones
- Speech intelligibility is the main priority
- High power requirement in the noisy pool area
- Fireman's panel by fire exit
- Call station in office/reception
- Additional public address functions for announcements
- BGM

### 3.2.3 Solution for a 5-zone system

The Plena Voice Alarm System controller handles routing to up to 6 zones, so no additional routers are required. The office/reception is equipped with a call station plus keypad for individually addressing zones, while a fireman's panel (with overall priority) is built in by the emergency exit. The Plena Voice Alarm System is a two-channel system, so BGM can still be provided in zones not receiving a call.

### 3.2.4 Power requirements

The system controller has a built-in 240 W power amplifier, making it possible to drive up to 40 loudspeakers with a power handling capacity of 6 W each. The pool area requires highpower music horn loudspeakers qualified for use in a high humidity atmosphere. The snack bar uses cabinet loudspeakers for music reproduction. The zones are defined as indicated in the table. An additional Plena Power Amplifier is used for two-channel operation and as a spare amplifier.

### 3.2.5 Layout

See figure 3.2, table 3.3 and table 3.4

table 3.3: Zones

Zone	Description	Power
Z1	Indoor pool area	5 x 30 W
Z2	Children's pool area	2 x 10 W
Z3	Changing rooms	4 x 6 W
Z4	Snackbar	4 x 6 W
Z5	Office	2 x 6 W
<b>Total</b>		<b>230 W</b>

table 3.4: Units

Unit	Description	No.
LBB1990/00	Controller	1 x
LBB1996/00	Remote control	1x
LBB1956/00	Call station	1x
LBB1957/00	Call station keypad	4x
LBB1930/00	Power Amplifier (240 W)	1x
PLN-DVDT	DVD Tuner	1x

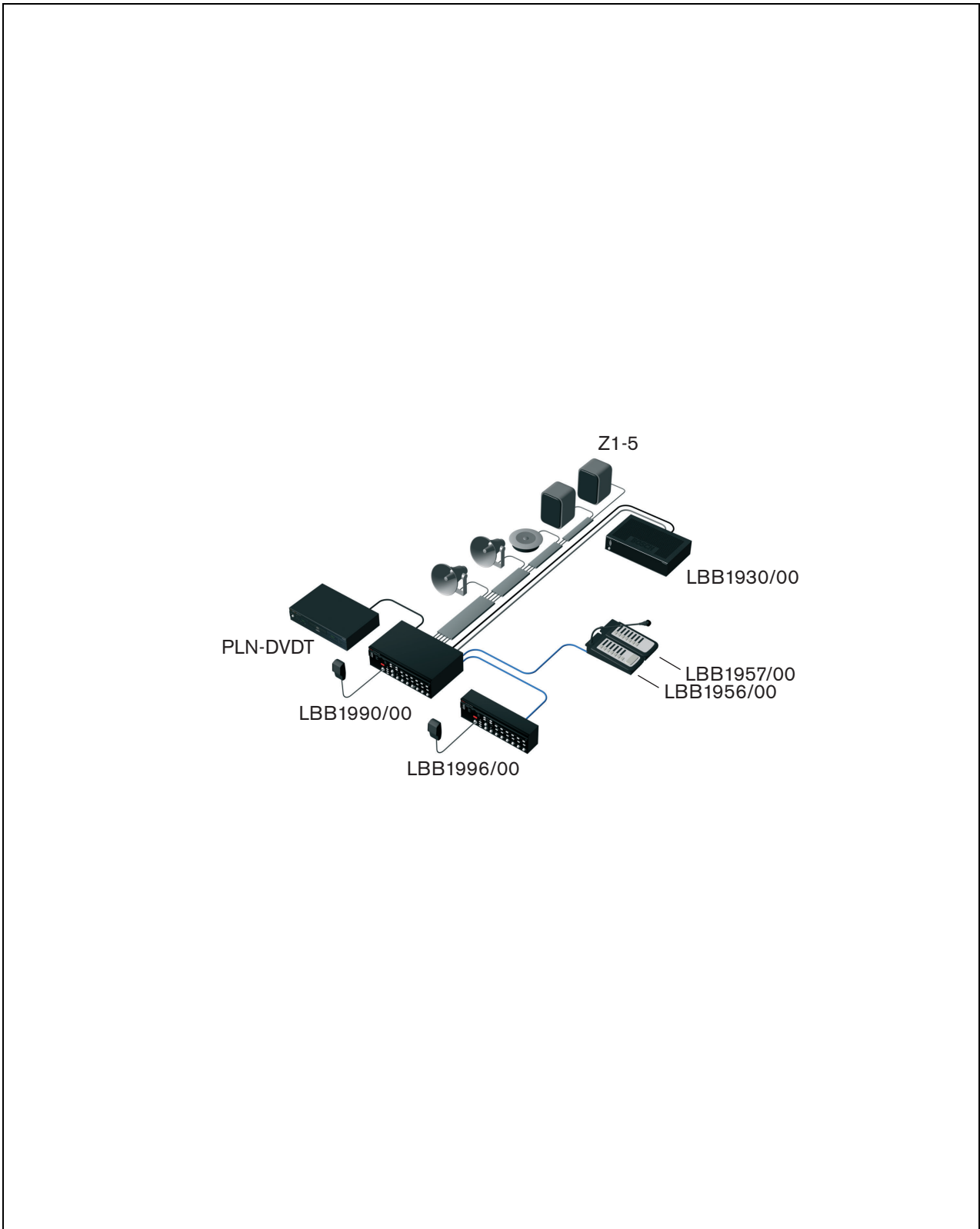

figure 3.2: Example of a swimming pool

## 3.3 Shopping mall

### 3.3.1 Introduction

Shopping malls are typical example of applications with a large number of zones with varying output power requirements per zone. The priorities are speech intelligibility and compliance with IEC60849 standard (and its national equivalents). In addition to mandatory voice alarm functionality for evacuating the public and shop personnel, an EVAC system for shopping centers can have BGM for the public areas. It should be possible to individually call each shop or store. During emergency messages, each shop's BGM volume control is automatically overridden. Additional public address functionality for making general public announcements is an optional requirement.

### 3.3.2 Summary of requirements

- Typically up to 60 zones
- Speech intelligibility is the main priority
- Variable power requirement per zone
- Call station in security control room
- Additional public address functionality (non-emergency)
- BGM in public areas
- BGM music with local override in shops

### 3.3.3 Solution for a 54-zone system

A Plena Voice Alarm System Controller handles routing to 6 zones, the remaining 48 zones require eight 6-zone routers. The security control room is equipped with a remote control panel and call station plus keypads for individually addressing zones and BGM for the public areas, while the controller unit and routers are located in a fire-resistant cabinet or basement. Fireman's panel (with overall priority) is built in close to the main entrance or emergency exit (subject to relevant local regulations). The Plena Voice Alarm System is a two-channel system, so BGM can still be provided in zones not receiving a call.

### 3.3.4 Power requirements

Each zone will have varying power requirements, ranging from small shops with a single loudspeaker to department stores with several floors and more loudspeakers. Parking garages and open-air walkways will require weatherproof sound projectors or horn loudspeakers. To facilitate phased evacuation from different levels of the shopping center, public areas are divided into zones. Additional Plena Power Amplifiers are incorporated to provide additional power, two-channel operation and for use as a spare amplifier.

### 3.3.5 Layout

See figure 3.3, table 3.5 and table 3.6

table 3.5: Zones

Zone	Description	Power
Z1-30	30 small shops/kiosks	30 x 6 W
Z31-36	6 shops	12 x 6 W
Z37-42	6 medium-sized stores	24 x 6
Z47	Security control room	1 x 6 W
Z48	Offices	4 x 6 W
Z49	Walkways ground floor	4 x 6 W
Z50	Gallery 1st floor	10 x 6 W
Z51	Gallery 2nd floor	10 x 6 W
Z52	Main public square	4 x 18 W
Z53	Parking garage level 1	6 x 10 W
Z54	Parking garage level 2	6 x 10 W
<b>Total</b>		<b>858 W</b>

table 3.6: Units

Unit	Description	No.
LBB1990/00	Controller	1 x
LBB1992/00	Router	8 x
LBB1996/00	Remote control	1 x
LBB1997/00	Remote control extension	8 x
LBB1956/00	Call station	1 x
LBB1957/00	Call station keypad	5 x
LBB1935/00	Power Amplifier (240 W)	1x
LBB1938/00	Power Amplifier (480 W)	2 x
PLN-DVDT	DVD Tuner	1x

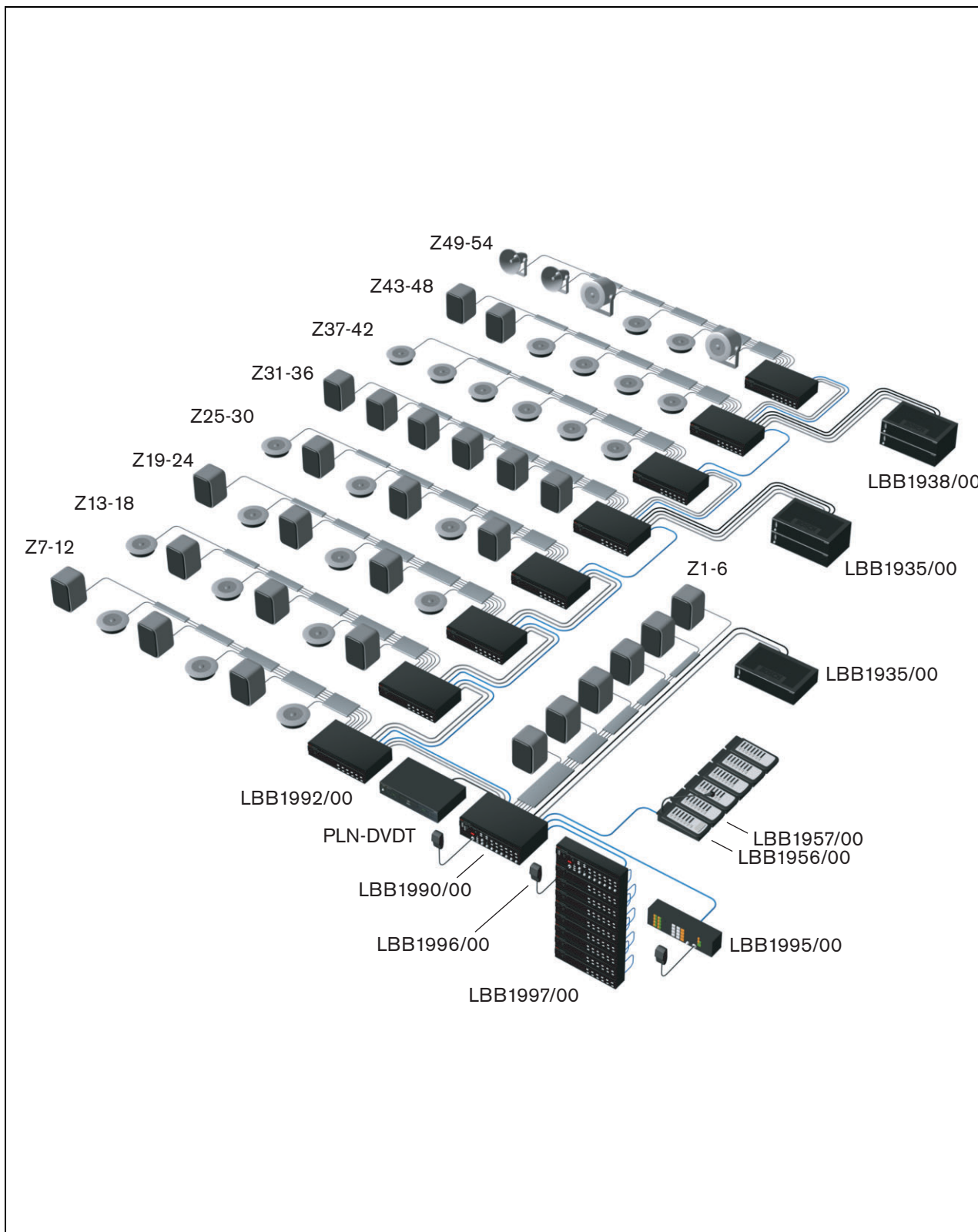

figure 3.3: Example of a shopping mall

## 3.4 Hotel

### 3.4.1 Introduction

Smaller hotels are typical examples of applications with relatively few zones, each with a medium to high output power requirement. The priorities are speech intelligibility and compliance with IEC60849 standard. In addition to mandatory voice alarm functionality for evacuating guests and staff, an EVAC system for a hotel should also include BGM in the restaurant, bar and lobby, plus public address functionality for general paging. To ensure that all guests hear an emergency message, the power output per zone is relatively high. Outside areas such as car parking garages, require weatherproof horn loudspeakers.

### 3.4.2 Summary of requirements

- Typically 10 to 20 zones in small hotels
- Speech intelligibility is the main priority
- High power requirement (multiple loudspeakers) per floor
- Fireman's panel by fire exit
- Call stations in reception and office
- Additional public address functions for paging guests
- BGM in lobby and restaurant

### 3.4.3 Solution for a 12-zone system

A Plena Voice Alarm System Controller handles routing to up to 6 zones, the additional 6 zones require a router. Both the reception and office are equipped with call stations plus keypads for individually addressing zones, while a fireman's panel (with overall priority) is built in by the emergency exit. The Plena Voice Alarm System is a two-channel system, so BGM can still be provided in zones not receiving a call.

### 3.4.4 Power requirements

The system controller features a built-in 240 W power amplifier, able to drive up to 40 loudspeakers (6 W). Additional Plena Power Amplifiers are incorporated to provide additional power, two-channel operation and spare amplification. To facilitate phased evacuation from different floors of the hotel, guest areas are divided into separate zones, each fitted with 13 ceiling loudspeakers in the corridors. The bar uses cabinet loudspeakers, while the parking garage uses weatherproof horn loudspeakers.

### 3.4.5 Layout

See figure 3.4, table 3.7 and table 3.8

table 3.7: Zones

Zone	Description	Power
Z1	Bar	3 x 6 W
Z2	Restaurant	6 x 6 W
Z3	Lobby	2 x 6 W
Z4	Office	1 x 6 W
Z5	Kitchens	2 x 6 W
Z6	Parking garage	3 x 10 W
Z7-12	Floors 1 to 6	78 x 6 W
<b>Total</b>		<b>582 W</b>

table 3.8: Units

Unit	Description	No.
LBB1990/00	Controller	1 x
LBB1992/00	Router	1 x
LBB1996/00	Remote control	1 x
LBB1997/00	Remote control extension	1 x
LBB1956/00	Call station	2 x
LBB1957/00	Call station keypad	3 x
LBB1935/00	Power Amplifier (240 W)	1 x
LBB1938/00	Power Amplifier (480 W)	2 x
PLN-DVDT	DVD Tuner	1 x

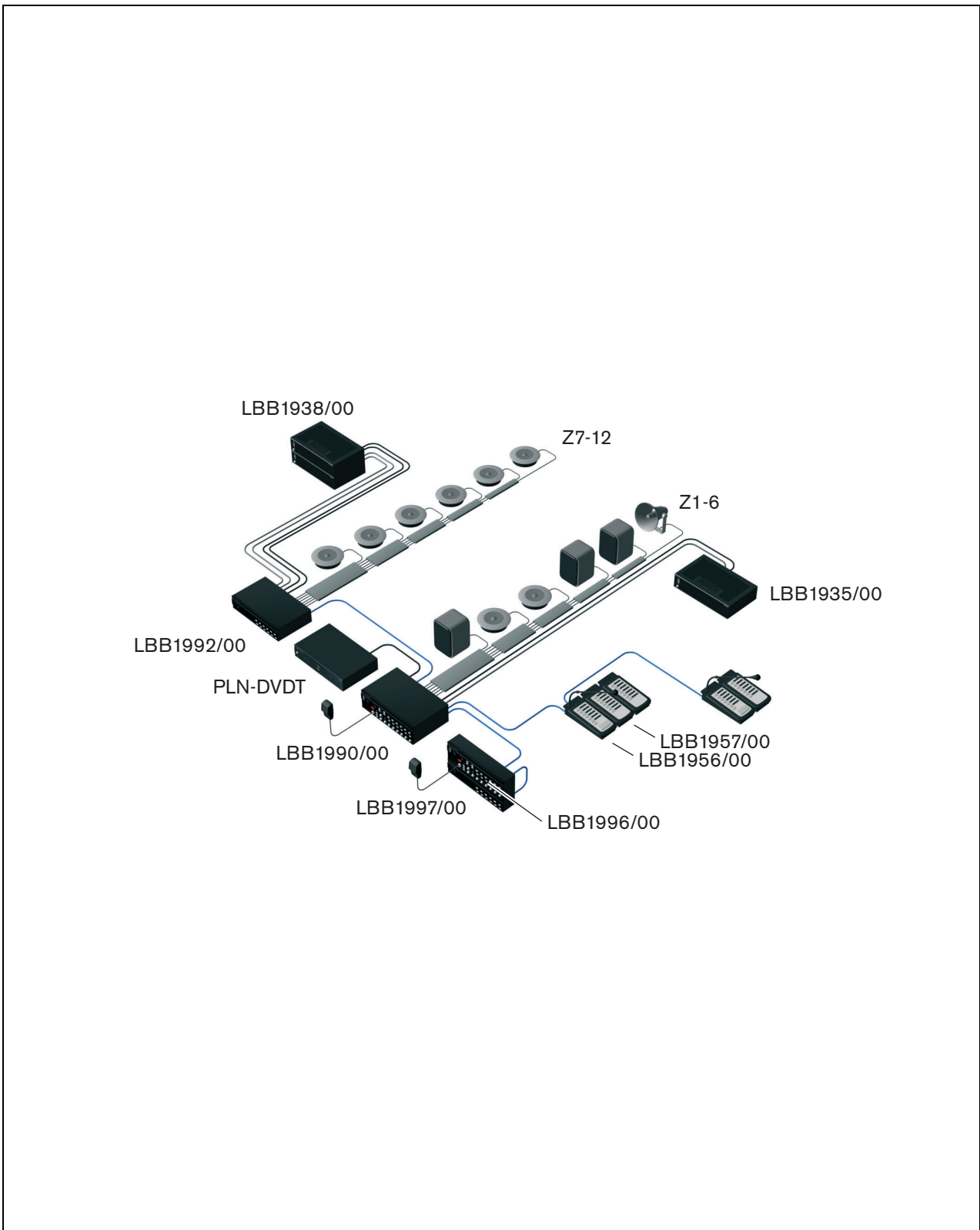

figure 3.4: Example of a hotel

## 4 Calls and priorities

### 4.1 Introduction

As the Plena Voice Alarm System is a public address and emergency sound system, it is used to distribute background music, business calls and emergency calls.

### 4.2 Priority

To each call, a priority is assigned. When two or more calls are addressed to the same zone or need shared resources (e.g. the internal message manager of the voice alarm controller), the call with the lower priority is stopped immediately and the call with the higher priority is started. The priority of a call depends on the part of the system that started the call and must be configured with the configuration software.

**Note**

See the Configuration Software Manual (9922 141 1038x) for more information about the configuration software.

When two or more calls with the same priority are addressed to the same zone or need shared resources (e.g. the internal message manager of the voice alarm controller), the oldest call is stopped immediately and the youngest call is started. An exception to this rule are mergeable messages (see section 4.3).

### 4.3 Mergeable messages

When two or more calls are started that are based on the same mergeable message template and have the same priority, the calls are merged. The youngest call will not stop the oldest call in this case. Mergeable message can be created with the configuration software.

### 4.4 Business call

A business call is a call that is made when the system is in the normal state. Business calls always have a priority between 2 and 8 and can be started with:

- Business trigger inputs.
- Call stations.
- The mic/line input with VOX functionality of the voice alarm controller.

### 4.5 Emergency call

An emergency call is a call that is made when the system is in the emergency state. Emergency calls have a priority between 9 and 19 and can be started with:

- Emergency trigger inputs.
- The hand-held emergency microphone of the voice alarm controller.
- The mic/line input with VOX functionality of the voice alarm controller.

Intentionally left blank.

## Section 2 - Equipment

## 5 LBB1990/00 Voice Alarm Controller

### 5.1 Controls, connectors and indicators

See figure 5.1 for an overview of the controls, connections and indicators on the voice alarm controller:

- 1 **Power LED/VU Meter** - A combined power indicator and VU meter. The green power LED is lit if the voice alarm controller is connected to the mains or back-up power and switched on. The VU meter indicates the master VU level: 0 dB (red), -6 dB, -20 dB (yellow).
- 2 **Fault indicators** - Twelve yellow system fault LEDs (Processor reset, Network, Call/EMG, Music/Spare, Ground short, Input, Mains, Battery, Message, EMG mic, RCP and Router) and twelve yellow loudspeaker line fault LEDs. Fault indication is only possible if supervision is enabled (see section 28.4). If supervision is disabled, the yellow Disabled LED is lit.
- 3 **Fault state buttons** - Two buttons to acknowledge (Ack) and reset (Reset) the fault state (see 28).
- 4 **Emergency state buttons** - Two buttons to acknowledge (Ack) and reset (Reset) the emergency state (see 27).
- 5 **Emergency call zone selectors** - Six buttons to select the zones to which the emergency call must be distributed (see 27). Each button has a green and a red LED. The six red LEDs indicate the zones that are selected for the emergency call. The six green LEDs indicate the zones in which a business call is running.
- 6 **BGM zone selectors** - Six buttons to select the zones to which the BGM is distributed (see 25). Each button has a green LED and a rotary knob. The six green LEDs indicate the zones to which BGM is distributed. The six rotary knobs are local volume controls that can be used to adjust the volume of the BGM in each zone.
- 7 **BGM master volume control** - A rotary knob to set the master volume of the BGM (see 25).
- 8 **BGM source selector** - A button to select the BGM source (CD/Tuner or Aux). The selected source is indicated with a green LED (see 25).
- 9 **BGM tone controls** - Two rotary knobs to control the high and low frequencies of the BGM (see 25).
- 10 **All call button** - A button to select all zones. This button is only available in the emergency state (see 27).
- 11 **Indicator test button** - A button to test all LEDs on the front panel of the voice alarm controller, and connected voice alarm routers, remote control panels, remote control extensions and fireman's panels. All LEDs are lit as long as the button is pushed (see 28).
- 12 **Emergency button** - A push button to put the system in the emergency state (see 27).
- 13 **Alert message button** - A button to select the alert message. This button is only available in the emergency state (see 27).
- 14 **Alarm message button** - A button to select the default alarm message. This button is only available in the emergency state (see 27).
- 15 **Microphone socket** - A socket to connect the hand-held emergency microphone (see section 5.3.1).
- 16 **Bracket** - A bracket for the hand-held emergency microphone that is supplied with the voice alarm controller.
- 17 **Monitoring speaker** - Built-in monitoring speaker.

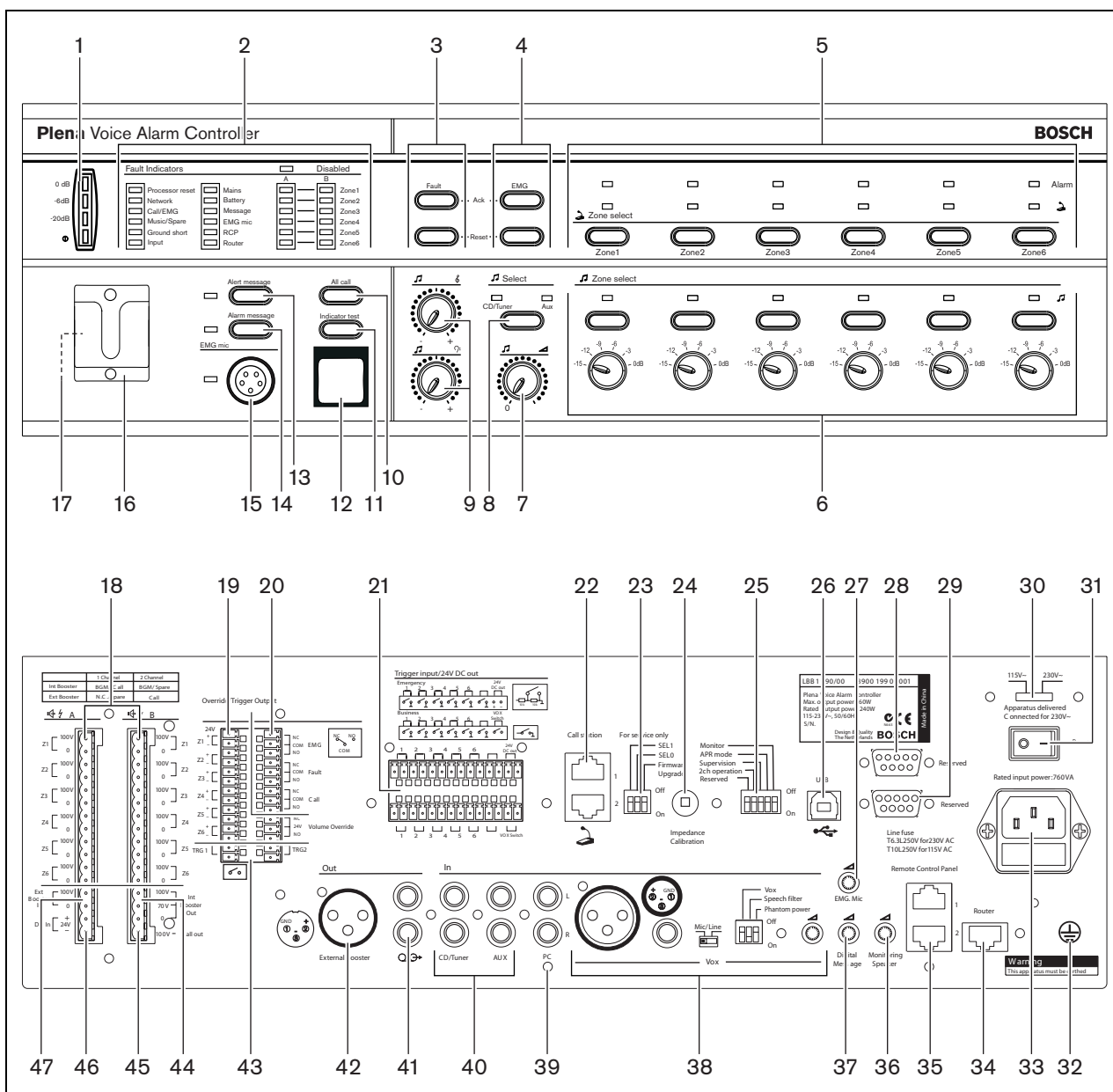



figure 5.1: Front and rear views of the voice alarm controller

- 18 **Zone outputs** - Six zone outputs to connect loudspeakers to the voice alarm controller. Each zone output consists of two loudspeaker line outputs (see section 5.3.6).
- 19 **Override outputs** - Six volume override outputs to override local volume controls in each zone (see section 5.3.7).

- 20 **Status outputs** - Three status outputs to send the status of the Plena Voice Alarm System to third party equipment (see section 5.3.11).
- 21 **Trigger inputs/24 V DC output** - Twelve trigger inputs to receive signals from third party equipment and one 24 V(DC) output (see section 5.3.13).

- 22 **Call station sockets** - Two redundant RJ45 sockets to connect call stations (LBB1956/00) to the voice alarm controller (see section 5.3.2).
- 23 **Service settings** - A set of DIP switches to service the voice alarm controller. Do not change the positions of the switches.
- 24 **Calibration switch** - A switch to calibrate the impedances of the loudspeaker lines for loudspeaker supervision (see section 24.3).
- 25 **Configuration settings** - A set of DIP switches to configure the system (see 17).
- 26 **PC socket** - A USB socket to connect the voice alarm controller to a PC.
- 

**Note**  
See the Configuration Software Manual (9922 141 1038x) for more information about connecting a PC to the voice alarm controller.
- 27 **Emergency microphone volume control** - A rotary knob to set the volume of the hand-held emergency microphone.
- 28 **Reserved** - For future use.
- 29 **Reserved** - For future use.
- 30 **Voltage selector** - A voltage selector to select the local mains voltage (see section 5.3.12).
- 31 **Power switch** - A switch to switch the voice alarm controller on and off (see section 5.3.12).
- 32 **Ground** - A connection to electrically ground the voice alarm controller.
- 33 **Mains power inlet** - A socket to connect the voice alarm controller to the mains power (see section 5.3.12).
- 34 **Router socket** - An RJ45 socket to connect voice alarm routers (LBB1992/00) to the voice alarm controller (see section 5.3.3).
- 35 **Remote control panel socket** - Two redundant RJ45 sockets to connect remote control panels (LBB1995/00, LBB1996/00, LBB1998/00) to the voice alarm controller.
- 36 **Monitoring speaker volume control** - A rotary knob to set the volume of the monitoring loudspeaker.
- 37 **Digital message volume control** - A rotary knob to set the volume of the digital messages. This volume control does not influence the volume of the emergency messages.
- 38 **Mic/line input with VOX functionality** - An XLR socket and a 6.3 mm jack with voice-activated (VOX) functionality to connect a microphone or line input to the voice alarm controller (see section 5.3.9). The VOX settings are configured with the DIP switches and the source switch (see section 19.1).
- 39 **PC Call station input** - An input to connect a PC call station. For future use.
- 40 **BGM inputs** - Two inputs to connect background music sources. Each input consists of two cinch sockets (see section 5.3.10).
- 41 **Line output** - A line output to connect an external recording device to record the audio of the Plena Voice Alarm System (see section 5.3.8).
- 42 **External power amplifier (output)** - An XLR socket to connect an external power amplifier (see section 5.3.4). This socket is used in combination with the external power amplifier input (no. 47).
- 43 **Trigger outputs** - Two general purpose trigger outputs. For future use.
- 44 **Internal power amplifier output** - Three pins that provide the 100 V audio signal of the internal power amplifier of the voice alarm controller.
- 45 **Call output** - An output that provides the call audio of the Plena Voice Alarm System.
- 46 **Back-up power inlet** - An inlet to connect a back-up power supply to the voice alarm controller (see section 5.3.12).
- 47 **External power amplifier (input)** - An input to connect an external power amplifier (see section 5.3.4). These pins are used in combination with the external power amplifier output (no. 42).



### 5.3.3 Voice alarm routers

The voice alarm controller has 1 socket for LBB1992/00 Voice Alarm Routers. Use shielded Cat-5 Ethernet cables with RJ45 plugs to connect a voice alarm router to the voice alarm controller. When the system requires more than 1 voice alarm router, use the system sockets on the voice alarm router to make loop-throughs. See figure 5.5 for connection details.

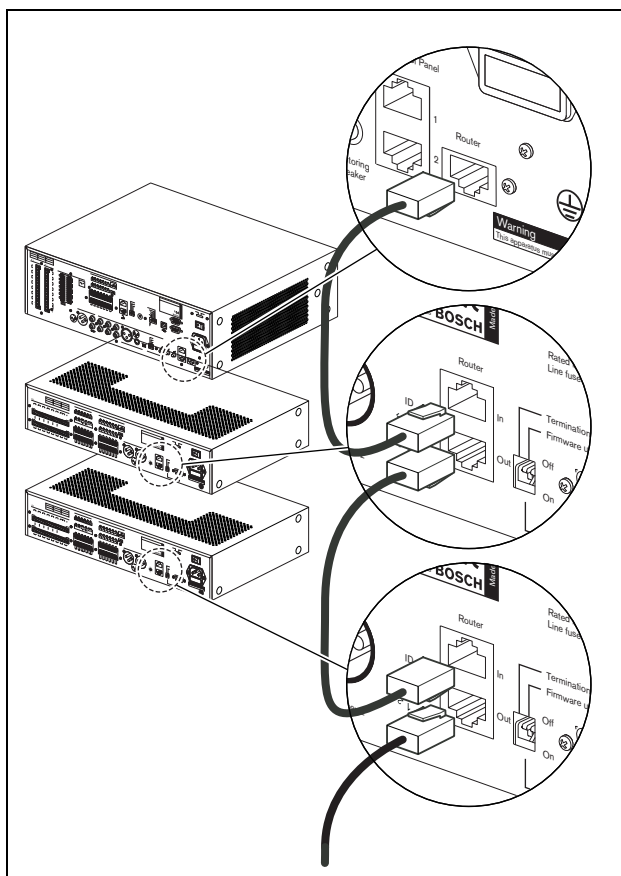

figure 5.5: Connecting routers

**Note**  
Each connected voice alarm router must have a unique ID (see 20).

### 5.3.4 External power amplifier

The voice alarm controller has 1 external power amplifier output (line level, 1 V) and 1 external power amplifier input (100 V) to connect an external power amplifier (see figure 5.6). The function of the external power amplifier (e.g. an LBB1930/00 Plena Power Amplifier) depends on the channel mode for which the voice alarm controller is configured (see section 17.5).

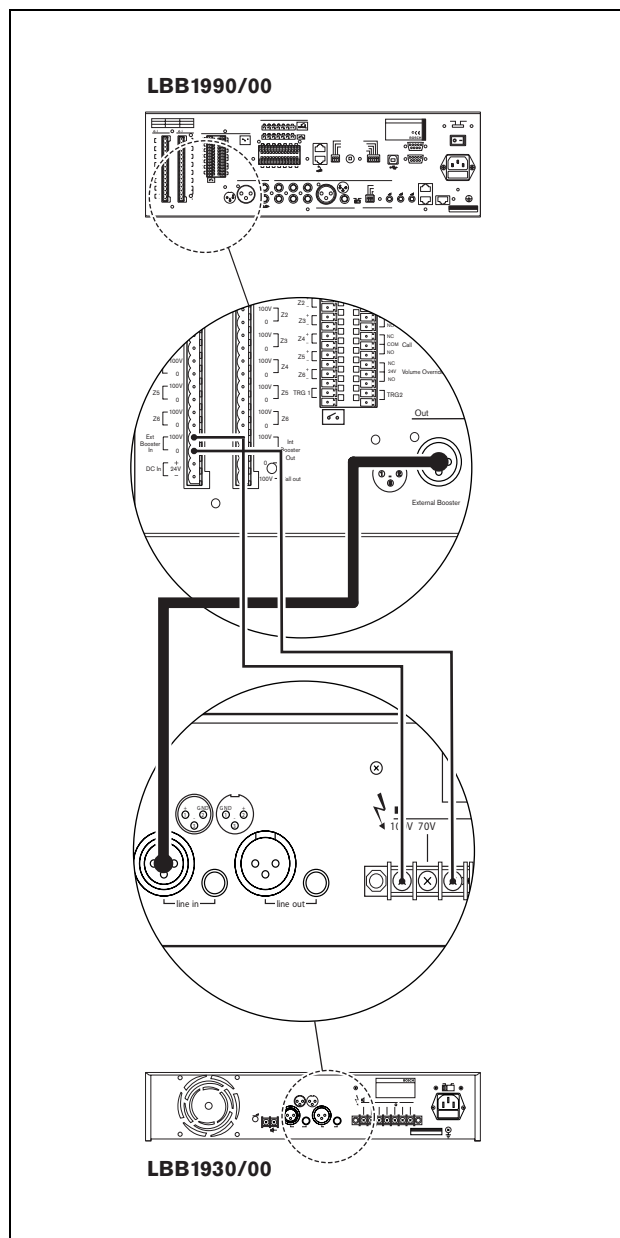

figure 5.6: Connecting an external power amplifier

### 5.3.5 Remote controls

The voice alarm controller has 2 sockets for remote controls. Use shielded Cat-5 Ethernet cables with RJ45 plugs to connect a remote control to the voice alarm controller. See figure 5.5 for connection details.

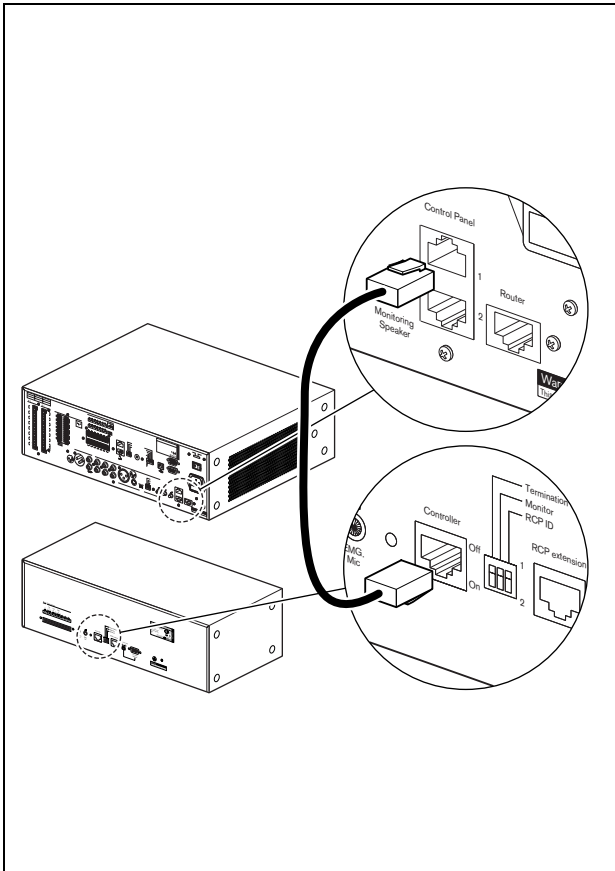

figure 5.7: Connecting a remote control

### 5.3.6 Loudspeakers

The voice alarm controller has 6 zone outputs (Z1 to Z6). Each zone output consists of 2 redundant loudspeaker lines (line A and line B). Normally, calls and BGM are distributed to a zone over both loudspeaker lines. If one of the loudspeaker lines of a zone fails, it is still possible to distribute calls and BGM to the zone over the remaining loudspeaker line (see figure 5.8).

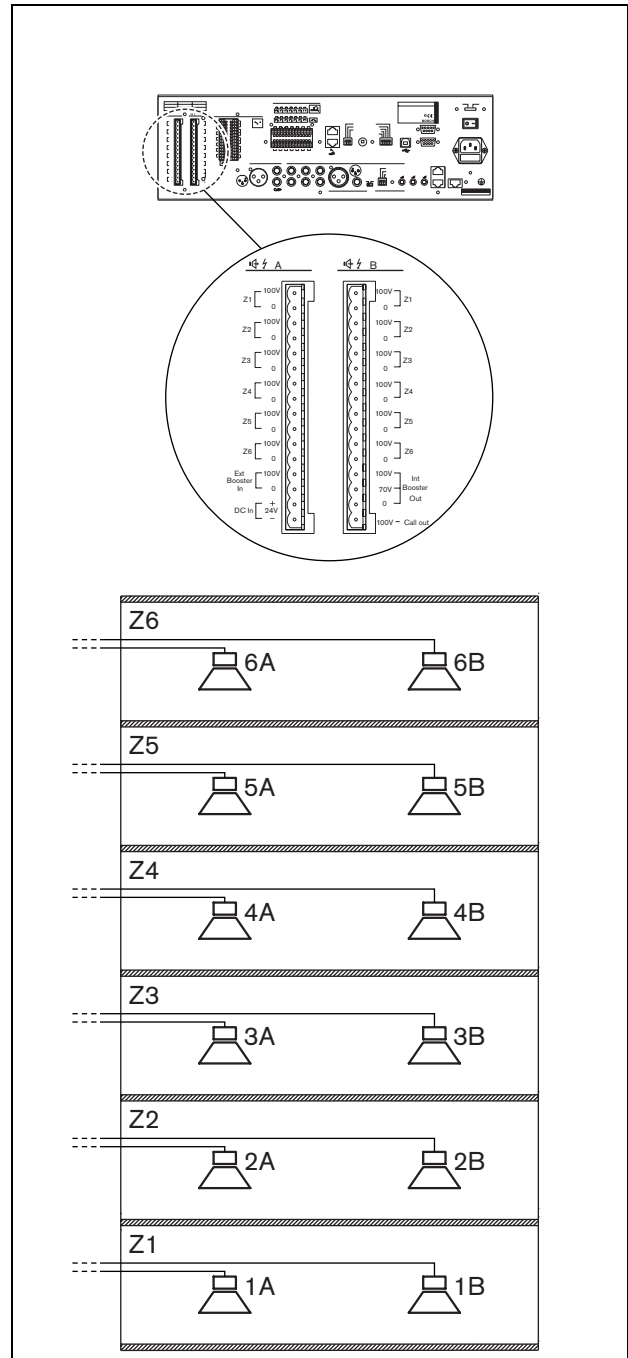

figure 5.8: Connecting loudspeaker zones

If it is necessary to detect the removal or failure of a single loudspeaker, the following is advised:

- Do not connect more than 5 loudspeakers to the same loudspeaker line (line A or line B). Field tests have shown that the impedance of loudspeakers and loudspeaker lines varies with temperature and age. The limit of 5 loudspeakers is set due to this variation. In a more stable environment, the number of loudspeakers can be higher.
- Make sure that all loudspeakers connected to the same loudspeaker line have the same impedance.



#### Note

The impedance measurement of the Plena Voice Alarm System has an accuracy better than 2%. The system only generates a fault if the line impedance difference is greater than the configured accuracy. Use the configuration software to configure the accuracy.



#### Note

See the Configuration Software Manual (9922 141 1038x) for more information about the configuration software.



#### Note

The maximum load for the internal power amplifier of the voice alarm controller is 240 W. However, if the voice alarm controller is used in 2-channel mode and an external 480 W amplifier is connected to it, the maximum loudspeaker load can be 480 W at 100 V. This is because in 2-channel mode, the internal power amplifier of the voice alarm controller is used for BGM only and distributes BGM at -3 dB, from which follows that the maximum power output is 240 W at 70 V and that the loading caused by 100 V loudspeakers at 70 V is also 240 W. The external amplifier is used for calls only with 480 W output power and 100 V loudspeaker line voltage.

### 5.3.7 Volume overrides

The voice alarm controller has 6 override outputs; 1 for each zone in the system (see figure 5.9). These are suitable for 4-wire override (24 V) and 3-wire override.



#### Note

By default, the voice alarm controller is configured for 4-wire (24 V), power-saving override, see situation I in figure 5.11.

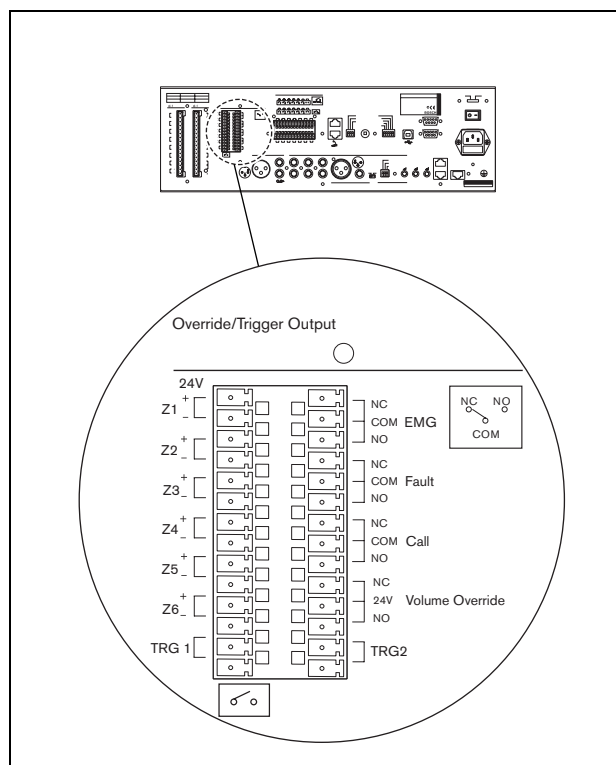

figure 5.9: Override outputs

Internally, the positive override pins (Z+) are all connected to either the NC or the NO contact of the Volume Override output (see figure 5.10). The negative override pins (Z-) are all connected to earth.

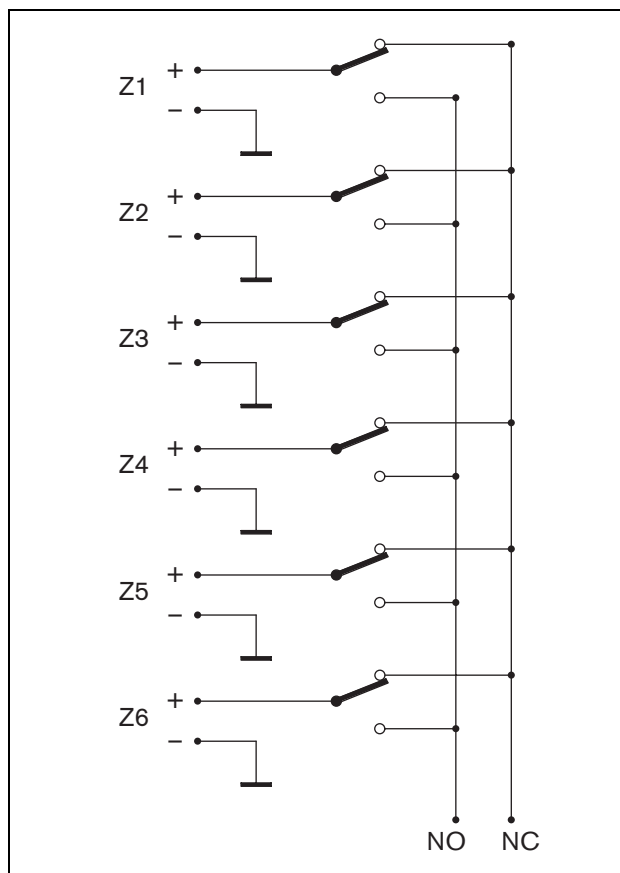

figure 5.10: Volume override contacts

Normally, when there are no active calls, the Z+ pins are internally connected to the NC contact of the Volume Override. At the moment a call is started in a zone, the Z+ pin of the zone is internally connected to the NO contact of the Volume Override. So, the NC and the NO contacts determine which voltage is supplied to the positive pins of the override outputs (Z+).

See figure 5.11, situation I for an example of a fail-safe 4-wire volume override:

- Connect the NO contact of the Volume Override to the 24V contact of the Volume Override.

See figure 5.11, situation II for an example of a power-saving 4-wire volume override:

- Connect the NC contact of the Volume Override to the 24V contact of the Volume Override.

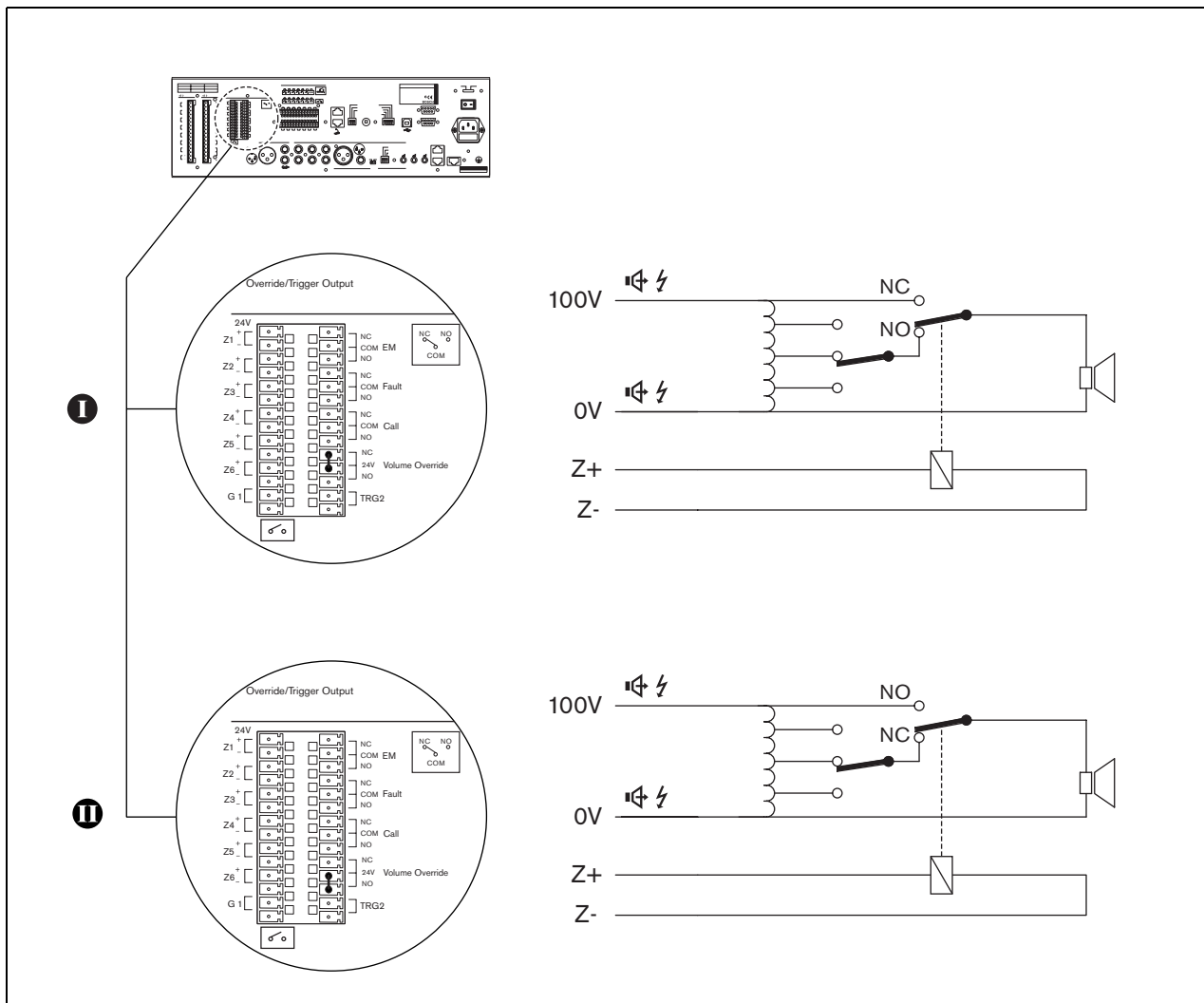

figure 5.11: 4-wire volume override

To create a 3-wire volume override, see figure 5.12:



#### Note

It is not possible to use 3-wire volume override in combination with redundant loudspeaker lines (line A and B, see figure 5.8) and supervision. If redundant loudspeaker lines are needed, use 4-wire volume override (see figure 5.11).

- Connect the 100 V output of loudspeaker line A to the 100 V input of the volume control.
- Connect the 100 V/0 V (CALL/RTN) of the transformer to the 100V output of loudspeaker line B.
- Connect the 0 output of loudspeaker line A to the 0 V of the loudspeaker.
- Enable 3-wire volume override in the configuration software.



#### Note

See the Configuration Software Manual (9922 141 1038x) for more information about the configuration software.



#### Caution

Make sure that the correct connections have been made and the system is correctly configured.

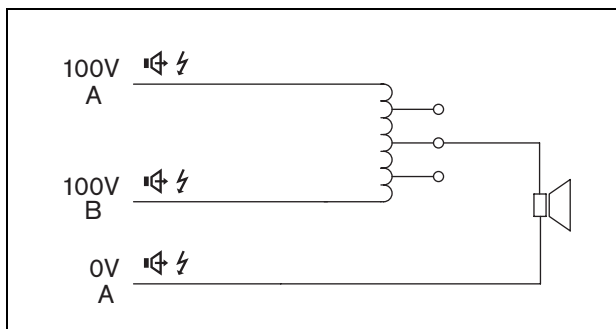

figure 5.12: 3-wire volume override

### 5.3.8 Line output

The voice alarm controller has 1 line output (see figure 5.13). This output has a double cinch socket. Both cinch sockets contain the same, mono signal, which consists of the current BGM and calls. The line output can be used to connect the voice alarm controller to a recording device (e.g. a tape-deck).

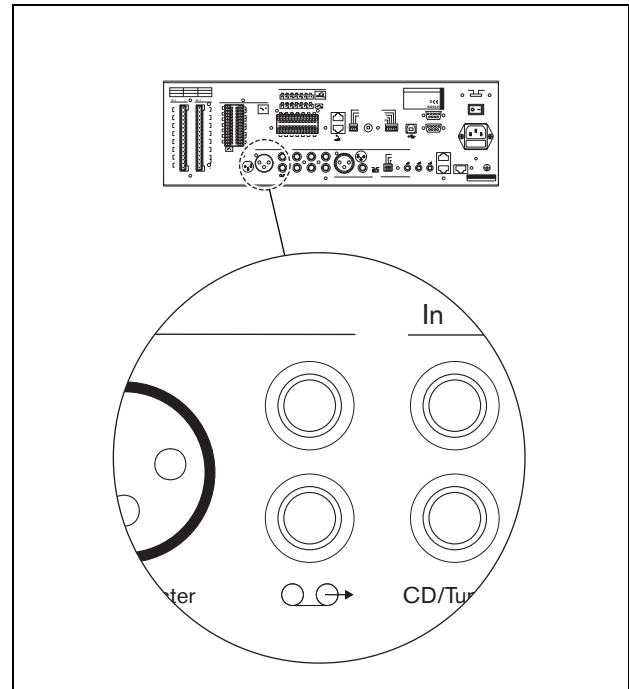

figure 5.13: Line output

### 5.3.9 Mic/line input with VOX functionality

The voice alarm controller has 1 mic/line input with voice-activated (VOX) functionality (see figure 5.14). This input has 2 sockets; a balanced XLR socket and a balanced 6.3 mm jack socket. The signals from both sockets are mixed to form a single input signal.

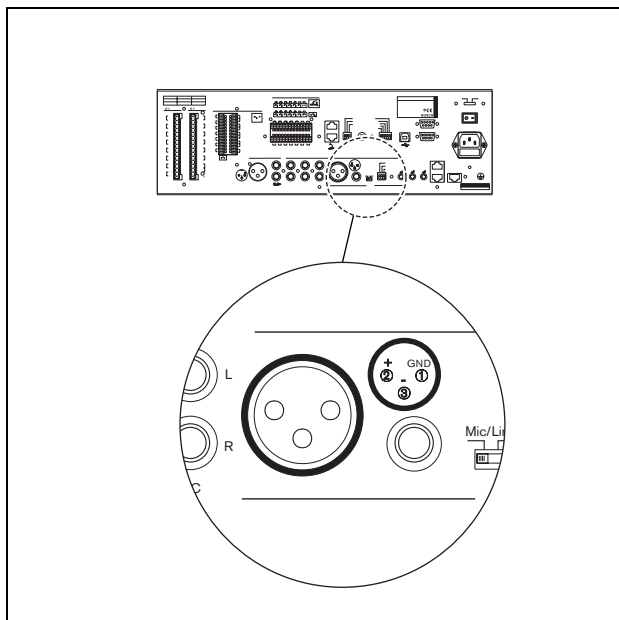

figure 5.14: Mic/line input with VOX functionality

The input automatically starts a business or emergency call if the input is higher than -20 dB (100 mV for line and 100  $\mu$ V for microphone inputs) or if the VOX switch is closed (see figure 5.15). The input must be configured with the configuration software.



**Note**

See the Configuration Software Manual (9922 141 1038x) for more information about the configuration software.

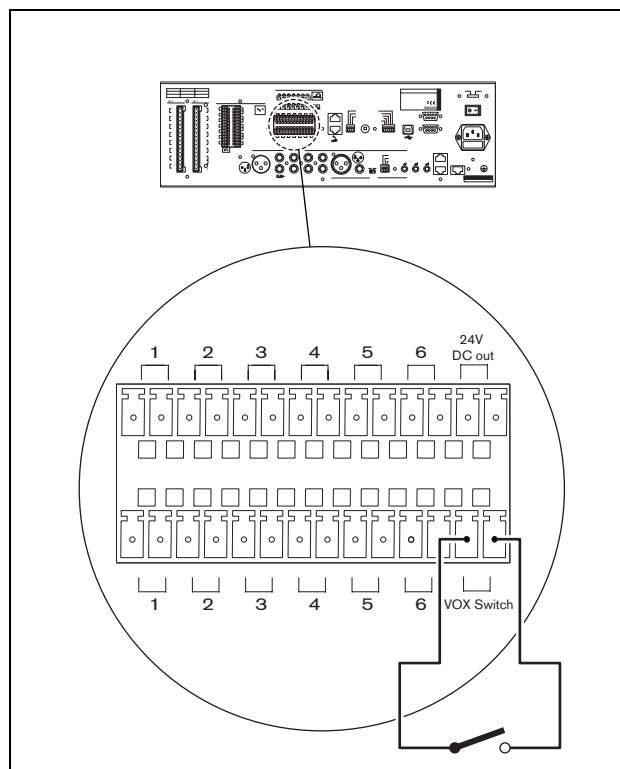

figure 5.15: Connecting a VOX switch

For example, the mic/line input with VOX functionality can be used to create a supervised link to another emergency sound system (e.g. a Praesideo system).

### 5.3.10 BGM inputs

The voice alarm controller has 2 BGM inputs (see figure 5.16 and table 5.1). Each BGM input has a double cinch socket. To these cinch outputs, a background music source can be connected (e.g. a PLN-DVDT Plena DVD Tuner). The signals connected to the L (left) and R (right) cinch sockets are mixed to form a single input signal.

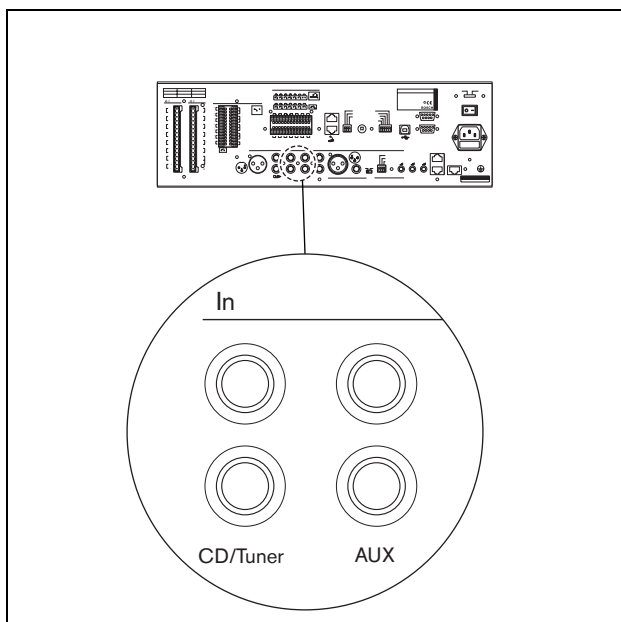

figure 5.16: BGM inputs

table 5.1: BGM inputs

Input	Source
CD/Tuner	CD or tuner
AUX	Auxiliary source

### 5.3.11 Status output contacts

The voice alarm controller has 3 status output contacts to indicate the current system state (see figure 5.17). These are used to send the status of the Plena Voice Alarm System to third party equipment or to connect sounders or similar indicating devices.

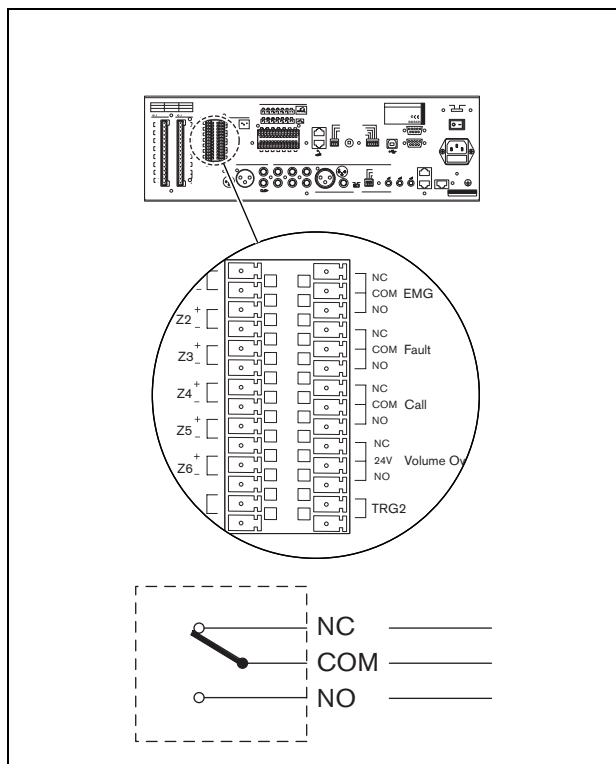

figure 5.17: Status output contacts (default)

table 5.2: Status output contact

Contact	Description
EMG	Emergency state. See 27
Fault	Fault state. See 28
Call	Call active state.

The status output contacts are internal relays. By default, NC is connected to COM. When the Plena Voice Alarm System enters one of the states that are indicated in table 5.2, the relay connects NO to COM.

### 5.3.12 Power

#### 5.3.12.1 Introduction

The voice alarm controller has the following power connections:

- Mains power connection (see section 5.3.12.2).
- Back-up power connection (see section 5.3.12.3).

#### 5.3.12.2 Mains power

Proceed as follows to connect the voice alarm controller to the mains power:

- 1 Select the local mains voltage using the voltage selector on the rear of the voice alarm controller.

- 2 Put the correct type of fuse in the voice alarm controller (see table 5.3).

**i Note**  
The LBB1990/00 Voice Alarm Controller is delivered with a T6.3L 250 V fuse for a mains voltage of 220 to 240 V(AC).

- 3 Connect a locally approved mains cord to the voice alarm controller (see figure 5.19).
- 4 Connect the mains cord to a locally approved mains outlet (see figure 5.19).

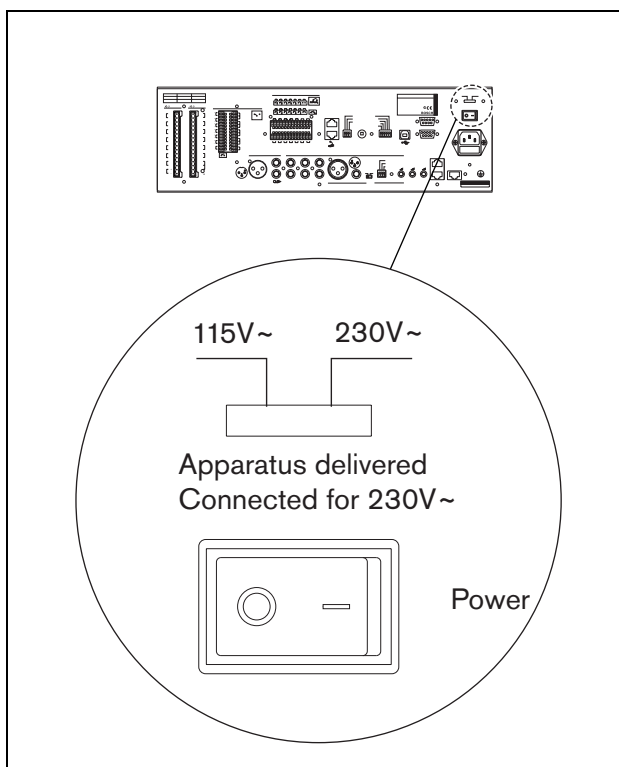

figure 5.18: Voltage selector

table 5.3: Voltage selector

Selector	Mains voltage V(AC)	Fuse
115	100 - 120	115 V - 10 AT
230	220 - 240	230 V - 6.3 AT

**i Note**  
The LBB1990/00 Voice Alarm Controller is delivered with the voltage selector in the 230 position.

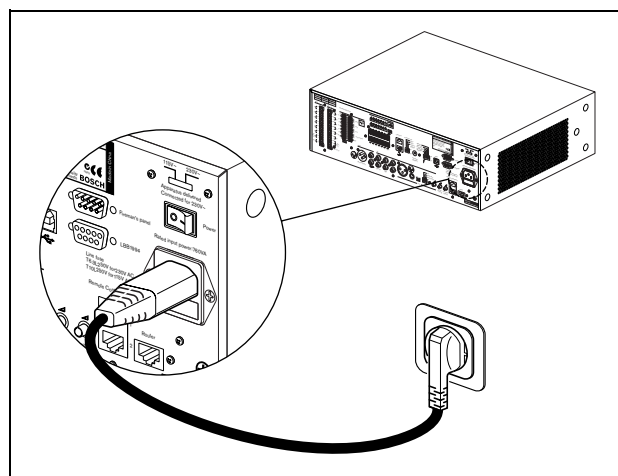

figure 5.19: Connecting the mains cord

### 5.3.12.3 Back-up power

The voice alarm controller has a 24 V(DC) input to connect a back-up power supply (e.g. a battery) which powers the system if the mains power is not available. See figure 5.20 for connection details.

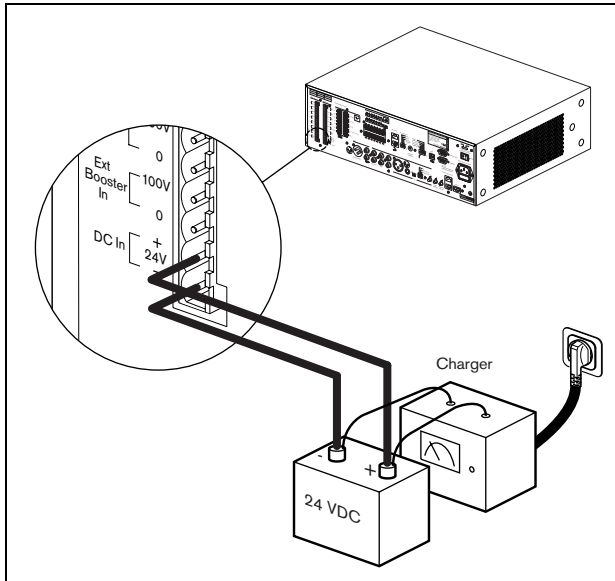

figure 5.20: Connecting a back-up power supply

### 5.3.13 Trigger inputs

#### 5.3.13.1 Introduction

The voice alarm controller has a terminal block to which 6 emergency (EMG) and 6 business trigger inputs can be connected. Third party systems can use the trigger inputs to start emergency and business calls in the Plena Voice Alarm System. The trigger inputs must be configured with the configuration software.

#### 5.3.13.2 Emergency trigger inputs

The upper part of the terminal block (see figure 5.21) contains the emergency trigger inputs. The emergency trigger inputs have a higher priority than the business trigger inputs.

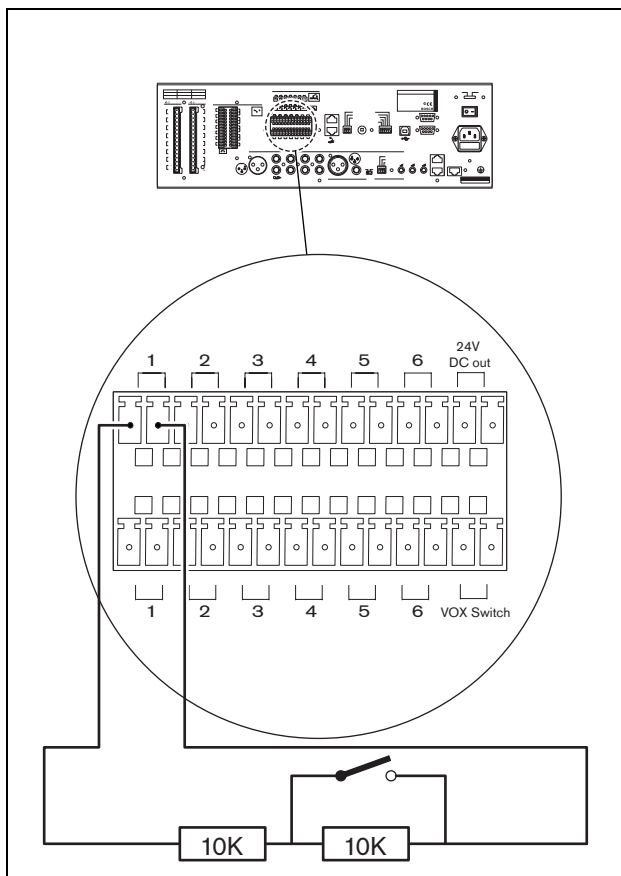

figure 5.21: Connecting emergency trigger inputs

#### 5.3.13.3 Business trigger inputs

The lower part of the terminal block (see figure 5.22) contains the business trigger inputs. The business trigger inputs have a lower priority than the emergency trigger inputs.

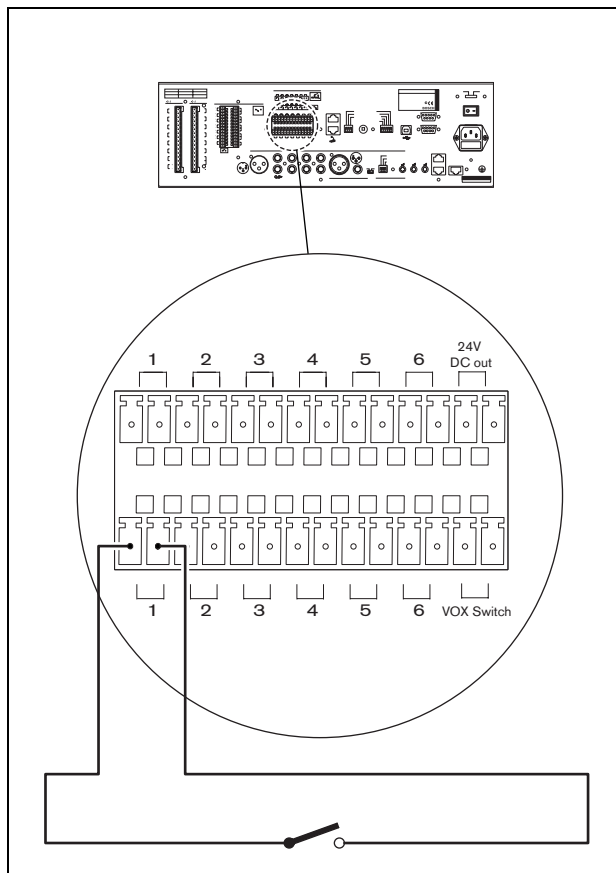

figure 5.22: Connecting business trigger inputs

## 5.4 Technical data

### 5.4.1 Electrical

**Mains voltage:**

230/115 V(AC),  $\pm 10\%$ , 50/60 Hz

**Mains current:**

0.3 A (system idle)

4.0 A (maximum load)

**Max. mains inrush current:**

6.3 A (for mains voltage of 220 - 240 V)

10 A (for mains voltage of 100 - 120 V)

**Battery voltage:**

20.0 to 26.5 V(DC)

**Battery current:**

0.9 A (system idle)

14 A (maximum load)

**Note**

Maximum load means maximum power out, maximum load 24 V(DC) out and maximum number of call stations.

### 5.4.2 Message manager

**Data format:**

WAV-file, 16-bit PCM, mono

**Supported sample rates (fs):**

24 kHz, 22.05 kHz, 16 kHz,

12 kHz, 11.025 kHz, 8 kHz

**Frequency response:**

@ fs = 24 kHz, 100 Hz - 11 kHz (+1/-3 dB)

@ fs = 22.05 kHz, 100 Hz - 10 kHz (+1/-3 dB)

@ fs = 16 kHz, 100 Hz - 7.3 kHz (+1/-3 dB)

@ fs = 12 kHz, 100 Hz - 5.5 kHz (+1/-3 dB)

@ fs = 11.025 kHz, 100 Hz - 5 kHz (+1/-3 dB)

@ fs = 8 kHz, 100 Hz - 3.6 kHz (+1/-3 dB)

**Distortion:**

< 0.1% @ 1 kHz

**Signal-to-noise ratio (flat at max. volume):**

> 80 dB

**Memory capacity:**

64 Mbit Flash

**Recording/playback time:**

1000 s @ fs = 8 kHz to 333 s @ fs = 24 kHz

**Number of messages:**

max. 254 wave files

**Supervision EEPROM:**

continuous checksum control

**Supervision DAC:**

1 Hz pilot tone

**Data retention time:**

> 10 years

### 5.4.3 Internal power amplifier

**Rated output power:**

240 W

**Frequency response:**

100 Hz - 18 kHz

(+1/-3 dB, @ -10 dB ref. rated output)

**Distortion:**

< 1% @ rated output power, 1 kHz

**Signal-to-noise ratio (flat at max. volume):**

> 85 dB

**Supervision:**

20 kHz pilot tone

**Outputs:**

70, 100 V screw terminal, 100 V call out

#### 5.4.4 Interconnection

**Call Station (LBB1956/00):**

RJ45 sockets, CAN bus  
max. 8 call stations

**Voice Alarm Router (LBB1992/00):**

RJ45 socket, CAN bus  
max. 9 routers

**Remote controls (LBB1995, LBB1996, LBB1997):**

RJ45 socket, CAN bus  
max. 2 remote controls

**PC:**

USB 2.0 (USB 1.1 compatible)

**External power amplifier**

3-pin XLR and screw terminals, max. 5 A  
max. rated output 1000 W

#### 5.4.5 Loudspeaker outputs

**Type:**

Screw terminals

**Number of zones:**

6

**Number of loudspeaker lines:**

12 (2 per zone)

**Signal-to-noise ratio (flat at max. volume):**

> 85 dB

**Line voltage:**

100 V

#### 5.4.6 Overrides

**Type:**

3-wire or 4-wire on screw terminals

**Voltage:**

24 V(DC) for 4-wire, if selected

**Current:**

total 0.8 A

#### 5.4.7 Trigger outputs

**Type:**

Screw terminals

**Voltage:**

Floating, max. 250 V

**Current:**

max. 0.5 A

#### 5.4.8 Trigger inputs/24 V DC out

**Trigger voltage:**

< 24 V

**Type:**

Momentary or latching

Normally opened (default) or normally closed

**Emergency input supervision:**

10 k $\Omega$  + 10 k $\Omega$  series and parallel resistors

**24 V DC out:**

24 V(DC), max. 0.8 A

**VOX switch:**

Normally opened

#### 5.4.9 Mic/line input with VOX functionality

**Type:**

3-pin XLR, 6.3 mm jack socket, balanced

**Sensitivity:**

1 mV +1/-3 dB (mic), 1 V +1/-3 dB (line)

**Impedance:**

> 10 k $\Omega$

**VOX threshold:**

500  $\mu$ V (mic), 500 mV (line)

#### 5.4.10 BGM

**Type:**

Cinch, stereo converted to mono

**Nominal input level:**

500 mV

#### 5.4.11 Line out

**Type:**

3-pin XLR, 6.3 mm jack socket, balanced

**Nominal output level:**

1 V

**Maximum output level:**

1 V

#### 5.4.12 External power amplifier

**Type:**

3-pin XLR and screw terminals

**Controller output/Amplifier input:**

1 V

**Controller input/Amplifier output:**

100 V

### 5.4.13 Environmental conditions

**Operating temperature range:**

-10 to +55 °C

**Storage temperature range:**

-40 to +70 °C

**Relative humidity:**

< 95%

### 5.4.14 General

**EMC emission:**

According to EN55103-1

**EMC immunity:**

According to EN55103-2

**Dimensions:**

19" wide, 3 U high, 360 mm deep

(leave 50 mm for connections)

**19" mounting brackets:**

included

**Weight:**

approx. 20 kg

## 6 LBB1992/00 Voice Alarm Router

### 6.1 Controls, connectors and indicators

See figure 6.1 for an overview of the controls, indicators and connectors on the voice alarm router:

- 1 **Power LED/VU Meter** - A combined power indicator and VU meter. The green power LED is lit if the voice alarm router is connected to the mains or back-up power and switched on. The VU meter indicates the master VU level: 0 dB (red), -6 dB, -20 dB (yellow).
- 2 **Fault indicators** - Eight yellow system fault LEDs (Processor reset, Network, Call/EMG, Music/Spare, Ground short, Input, Mains, Battery) and twelve yellow loudspeaker line fault LEDs. Fault indication is only possible if supervision is enabled (see section 28.4).
- 3 **Emergency call zone selectors** - Six buttons to select the zones to which the emergency call must be distributed (see 27). Each button has a green and a red LED. The six red LEDs indicate the zones that are selected for the emergency call. The six green LEDs indicate the zones in which a business call is running.
- 4 **BGM zone selectors** - Six buttons to select the zones to which the BGM is distributed (see 25). Each button has a green LED. The six green LEDs indicate the zones to which BGM is distributed.
- 5 **Zone outputs** - Six zone outputs to connect loudspeakers to the voice alarm router. Each zone output consists of two loudspeaker line outputs (see section 6.3.2).
- 6 **External power amplifier 1 (input)** - An input to connect an external power amplifier (see section 6.3.5). These pins are used in combination with the external power amplifier output (no. 18).
- 7 **Call output** - An output that provides the call audio of the Plena Voice Alarm System.
- 8 **Override outputs** - Six volume override outputs to override local volume controls in each zone (see section 6.3.3).
- 9 **Trigger inputs** - Twelve trigger inputs to receive signals from third party equipment (see section 6.3.4).
- 10 **Voltage selector** - A voltage selector to select the local mains voltage (see section 6.3.6).
- 11 **Power switch** - A switch to switch the voice alarm router on and off (see section 6.3.6).
- 12 **Mains power inlet** - A socket to connect the voice alarm router to the mains power (see section 6.3.6).
- 13 **Ground** - A connection to electrically ground the voice alarm controller.
- 14 **Firmware upgrade connector** - An RS232 connector to connect a PC to upgrade the firmware of the voice alarm router.
- 15 **Configuration settings** - A set of DIP switches to configure the voice alarm router (see 20).
- 16 **System sockets** - Two RJ45 socket to connect other voice alarm routers to the voice alarm router (see section 6.4.2)
- 17 **Router ID** - A rotary switch to set the ID of the router (see 20).
- 18 **External power amplifier (output)** - Two XLR sockets to connect external power amplifiers (see section 5.3.4). This socket is used in combination with the external power amplifier inputs (no. 6 and 24).
- 19 **Volume override** - Three contacts (NC/24V/NO) to connect a fail-safe or a power-saving 4-wire volume override (see section 5.3.7).

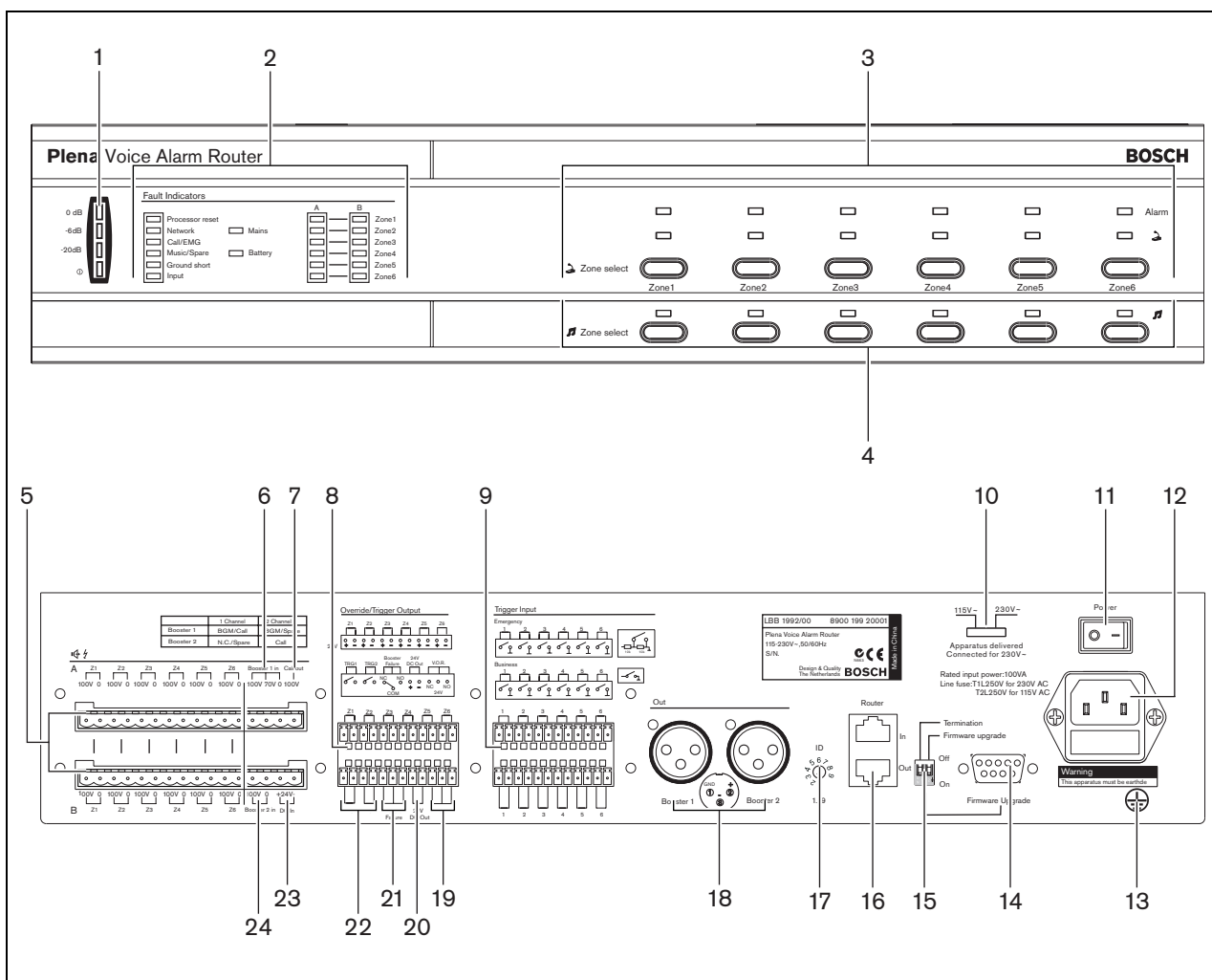

figure 6.1: Front and rear views of the voice alarm router

- 20 **24 V DC output** - One 24 V(DC) output.
- 21 **Power amplifier failure** - Two pins (NC relays) to report a failure of the power amplifier.
- 22 **Trigger outputs** - Two general purpose trigger outputs. For future use.
- 23 **Back-up power inlet** - An inlet to connect a back-up power supply to the voice alarm router (see section 6.3.6).
- 24 **External power amplifier 2 (input)** - An input to connect an external power amplifier (see section 6.4.6). These pins are used in combination with the external power amplifier output (no. 18).

## 6.2 Installation

The voice alarm router is suitable for table-top and 19-inch rack mounting installation. Two brackets for rack-mounting are supplied. Installing a voice alarm router is similar to installing a voice alarm controller (see section 5.2).

## 6.3 External connections

### 6.3.1 Voice alarm controller

Connect the voice alarm router to the voice alarm controller (see section 5.3.3).

### 6.3.2 Loudspeakers

The voice alarm router has 6 zone outputs (Z1 to Z6). The procedure for connecting loudspeakers to a voice alarm router is the same as the procedure for connecting loudspeakers to a voice alarm controller (see section 5.3.6).

### 6.3.3 Volume overrides

The voice alarm router has 6 override outputs; 1 for each connected zone. These are suitable for 4-wire override (24 V) and for 3-wire override. The procedure for using volume override in zones that are connected to a voice alarm router is the same as the procedure for using volume override in zones that are connected to the voice alarm controller (see section 5.3.7).

### 6.3.4 Trigger inputs

The voice alarm router has a terminal block to which 6 emergency (EMG) and 6 business trigger inputs can be connected. Third party systems can use the trigger inputs to start emergency and business calls in the Plena Voice Alarm System. The trigger inputs must be configured with the configuration software. The procedure for connecting trigger inputs to a voice alarm router is similar to the procedure for connecting trigger inputs to the voice alarm controller (see section 5.3.13).

### 6.3.5 External power amplifiers

The voice alarm router has 2 external power amplifier outputs (line level, 1 V) and 1 external power amplifier input (100 V) to connect two external power amplifiers. The function of the external power amplifier (e.g. an LBB1930/00 Plena Power Amplifier) depends on the channel mode for which the system is configured (see section 17.5). See figure 6.2 for information about connecting external power amplifier 1 to a voice alarm router.

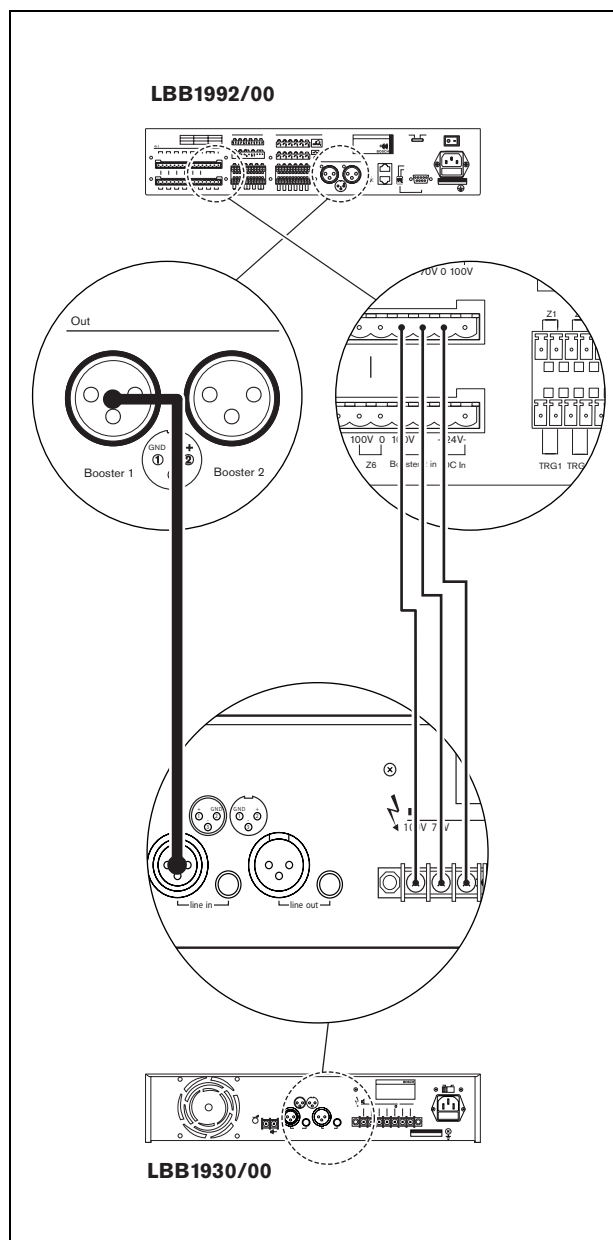

figure 6.2: Connecting external power amplifier 1

See figure 6.3 for information about connecting external power amplifier 2 to a voice alarm router.

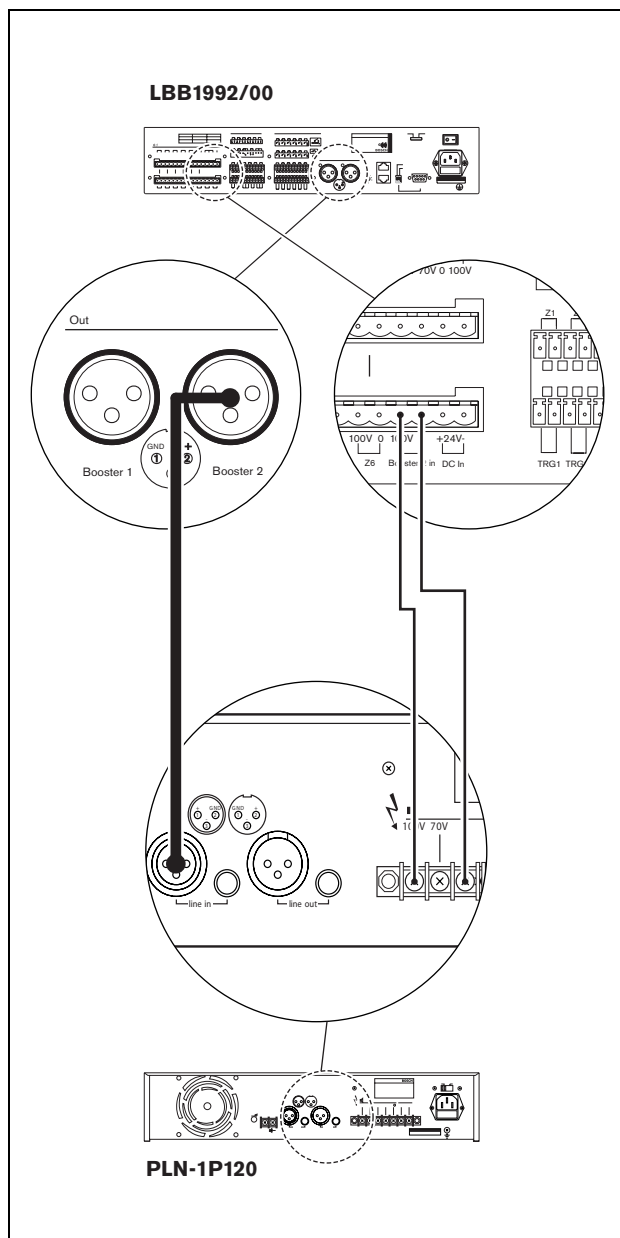

figure 6.3: Connecting external power amplifier 2



#### Note

The internal power amplifier of the voice alarm controller can also be used as external power amplifier for the voice alarm router.

### 6.3.6 Power

The procedure for connecting a voice alarm router to the mains power is the same as the procedure for connecting the voice alarm controller to the mains (see section 5.3.12.2). The procedure for connecting a voice alarm router to a back-up power supply is the same as the procedure for connecting the voice alarm controller to the mains (see section 5.3.12.3).

## 6.4 Technical data

### 6.4.1 Electrical

**Mains voltage:**

230/115 V(AC),  $\pm 10\%$ , 50/60 Hz

**Mains current:**

0.2 A (system idle)

0.3 A (maximum load)

**Max. mains inrush current:**

1.5 A (for mains voltage of 220 - 240 V)

3.0 A (for mains voltage of 100 - 120 V)

**Battery voltage:**

20.0 to 26.5 V(DC)

**Battery current:**

0.5 A (system idle)

1.5 A (maximum load)

**Note**

Maximum load means maximum power out, maximum load 24 V(DC) out and maximum number of call stations.

### 6.4.2 Interconnection

**Voice Alarm Router (LBB1992/00):**

RJ45 socket, CAN bus

max. 2 routers

**External power amplifiers:**

3-pin XLR and screw terminals, max. 5 A

max. rated output 1000 W

### 6.4.3 Loudspeaker outputs

**Type:**

Screw terminals

**Number of zones:**

6

**Number of loudspeaker lines:**

12 (2 per zone)

**Signal-to-noise ratio (flat at max. volume):**

> 85 dB

**Line voltage:**

100 V

### 6.4.4 Overrides

**Type:**

3-wire or 4-wire on screw terminals

**Voltage:**

24 V(DC) for 4-wire, if selected

**Current:**

total 0.8 A

### 6.4.5 Trigger inputs/24 V DC out

**Trigger voltage:**

< 24 V

**Type:**

Momentary or latching

Normally opened (default) or normally closed

**Emergency input supervision:**

10 k $\Omega$  + 10 k $\Omega$  series and parallel resistors

**24 V DC out:**

24 V(DC), max. 0.8 A

### 6.4.6 External power amplifiers

**Type:**

3-pin XLR and screw terminals

**Router output/Amplifier input:**

1 V

**Router input/Amplifier output voltage:**

100 V

### 6.4.7 Environmental conditions

**Operating temperature range:**

-10 to +55 °C

**Storage temperature range:**

-25 to +55 °C

**Relative humidity:**

< 95%

### 6.4.8 General

**EMC emission:**

According to EN55103-1

**EMC immunity:**

According to EN55103-2

**Dimensions:**

19" wide, 2 U high, 250 mm deep

(leave 50 mm for connections)

**19" mounting brackets:**

included

**Weight:**

approx. 3 kg

## 7 LBB1956/00 Call Station

### 7.1 Controls, connectors and indicators

See figure 7.1 for an overview of the controls, indicators and connectors on the call station:

- 1 **Power indicator** - A green LED to indicate that the call station is powered on.
- 2 **Zone selection buttons** - Six buttons to select the zones to which the business call is distributed (see 26). Each button has a green LED, which indicates the zones to which the business call is distributed.
- 3 **'All call' selector** - A button to select all zones (see 26).
- 4 **Push-to-talk button** - A push-to-talk (PTT) button to start the business call.
- 5 **Status indicators** - Three LEDs that indicate the status of the call station (see 26).
- 6 **Keypad connector** - A connector to connect call station keypads (LBB1957/00) to the call station.
- 7 **Configuration settings** - A set of DIP switches to configure the call station (see 21).
- 8 **Power supply inlet** - A socket to connect a 24 V(DC) power supply (see section 7.2.2).
- 9 **System sockets** - Two redundant RJ45 sockets to connect the call station to the voice alarm controller (LBB1990/00, see section 5.3.2).

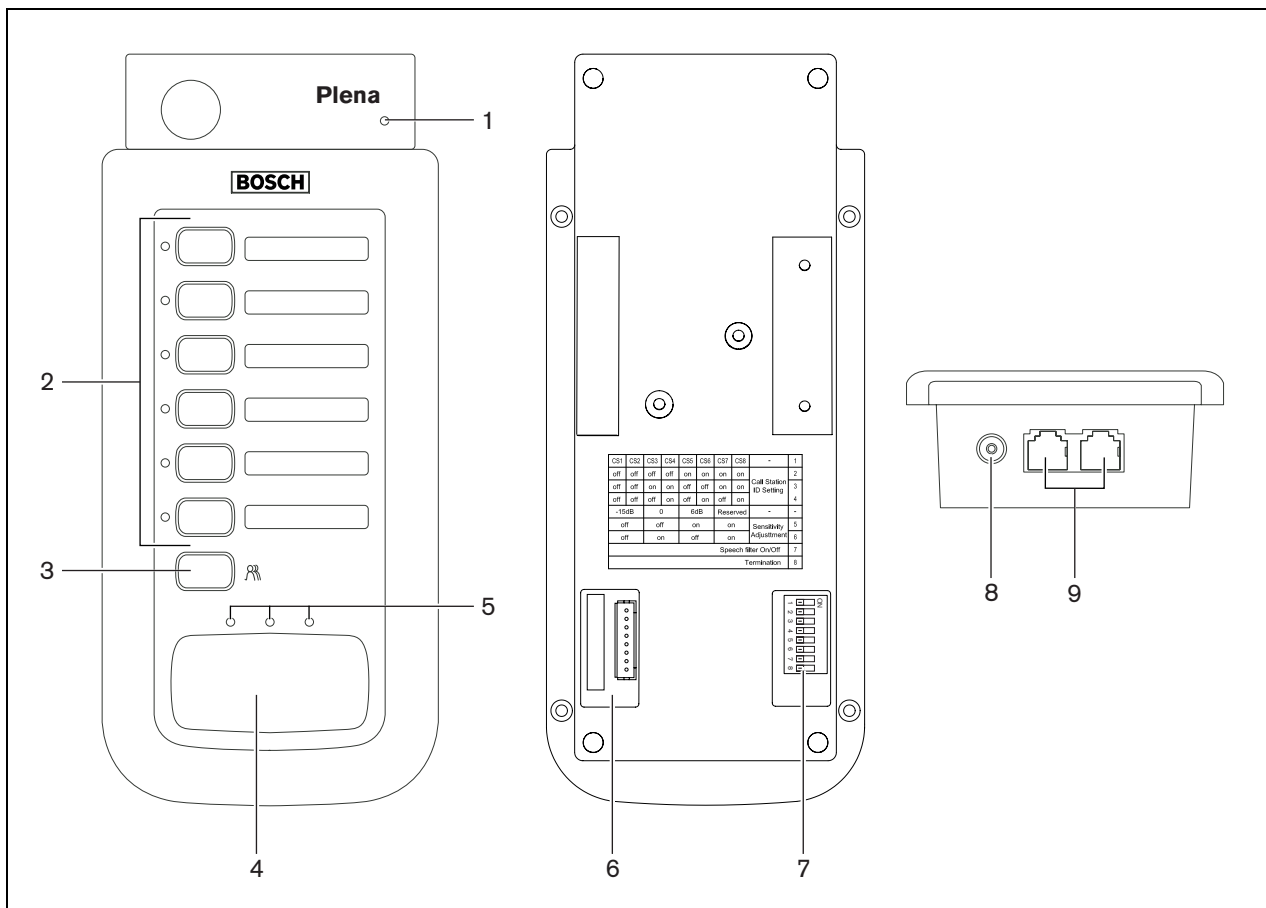

figure 7.1: Top and bottom views of the call station

## 7.2 External connections

### 7.2.1 Voice alarm controller

Connect the call station to the voice alarm controller (see section 5.3.2).

### 7.2.2 Power supply

If the cable between the voice alarm controller or the previous call station is longer than 100 m, the call station must be connected to a 24 V(DC) power source. See figure 7.2 for connection details.

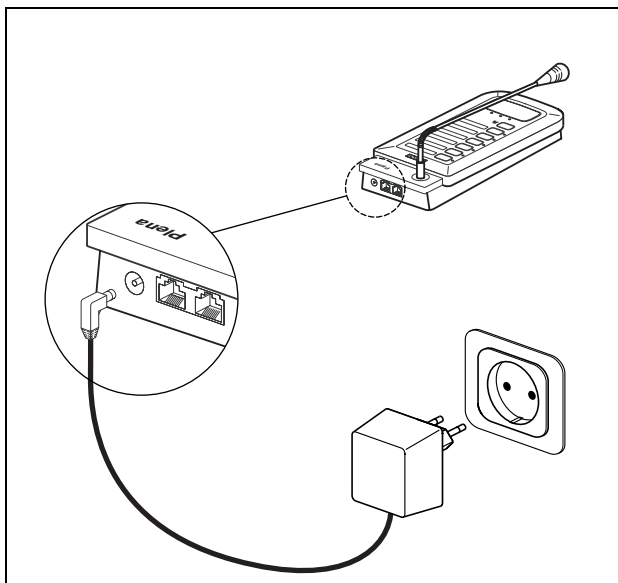

figure 7.2: Connecting a power supply

### 7.2.3 Keypads

The maximum number of keypads that can be connected to a call station is 8 (see section 8.2).

## 7.3 Technical data

### 7.3.1 Electrical

**Voltage range:**

24 V(DC), +20%/-10%, supplied by LBB1990/00 or external power source.

**Current consumption:**

< 30 mA

### 7.3.2 Performance

**Nominal sensitivity:**

85 dB SPL (gain preset 0 dB)

**Nominal output level:**

355 mV

**Maximum input sound level:**

110 dB SPL

**Gain preset:**

+6/0/-15 dB

**Limiter threshold:**

2 V

**Compression ratio limiter:**

20:1

**Distortion:**

< 0.6% (nominal input)

< 5% (maximum input)

**Equivalent input noise level:**

25 dB SPL(A)

**Frequency response:**

100 Hz - 16 kHz

**Speech filter:**

- 3 dB @ 500 Hz, high-pass, 6 dB/oct

**Output impedance:**

200  $\Omega$

### 7.3.3 Interconnection

**Type:**

2x redundant RJ45 sockets to connect the call station to the voice alarm controller with Cat-5 Ethernet cables.

### 7.3.4 Environmental conditions

**Operating temperature range:**

-10 to +55 °C

**Storage temperature range:**

-40 to +70 °C

**Relative humidity:**

< 95%

### 7.3.5 General

**EMC emission:**

According to EN55103-1

**EMC immunity:**

According to EN55103-2

**Dimensions:**

40 x 100 x 235 (base)

390 mm stem length (with microphone)

**Weight:**

approx. 1 kg

## 8 LBB1957/00 Call Station Keypad

### 8.1 Controls, connectors and indicators

See figure 8.1 for an overview of the controls, indicators and connectors on the call station keypad:

- 1 **Zone selection buttons** - Six buttons to select the zones to which the business call is distributed (see 26). Each button has a green LED, which indicates the zones to which the business call is distributed.
- 2 **Keypad connector** - A connector to connect call station keypads to the call station (LBB1956/00) or to other call station keypads (see section 8.2).

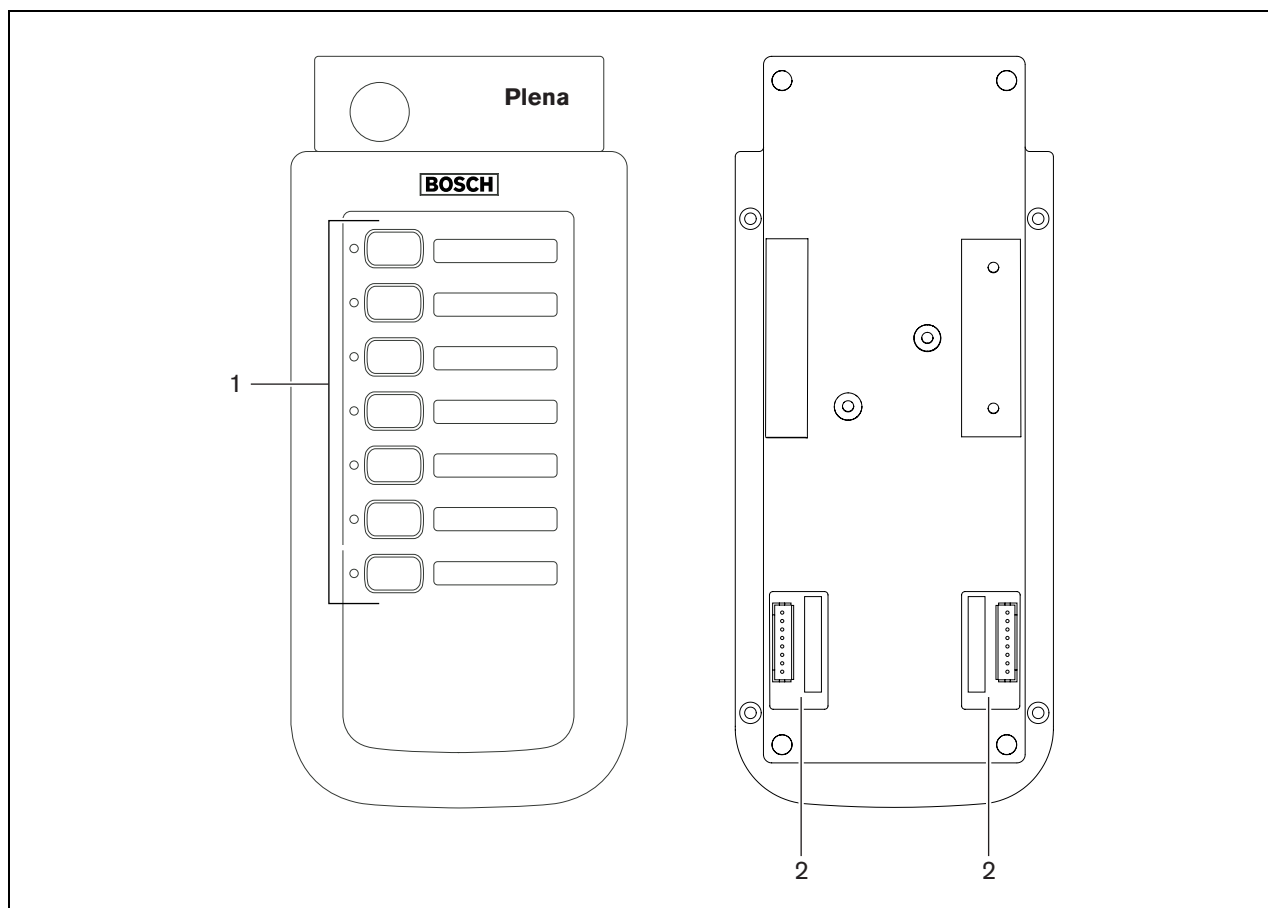

figure 8.1: Top and bottom views of the call station keypad

## 8.2 Installation

Call station keypads can be connected to call stations (LBB1956/00) or to other call station keypads (see section figure 8.2).

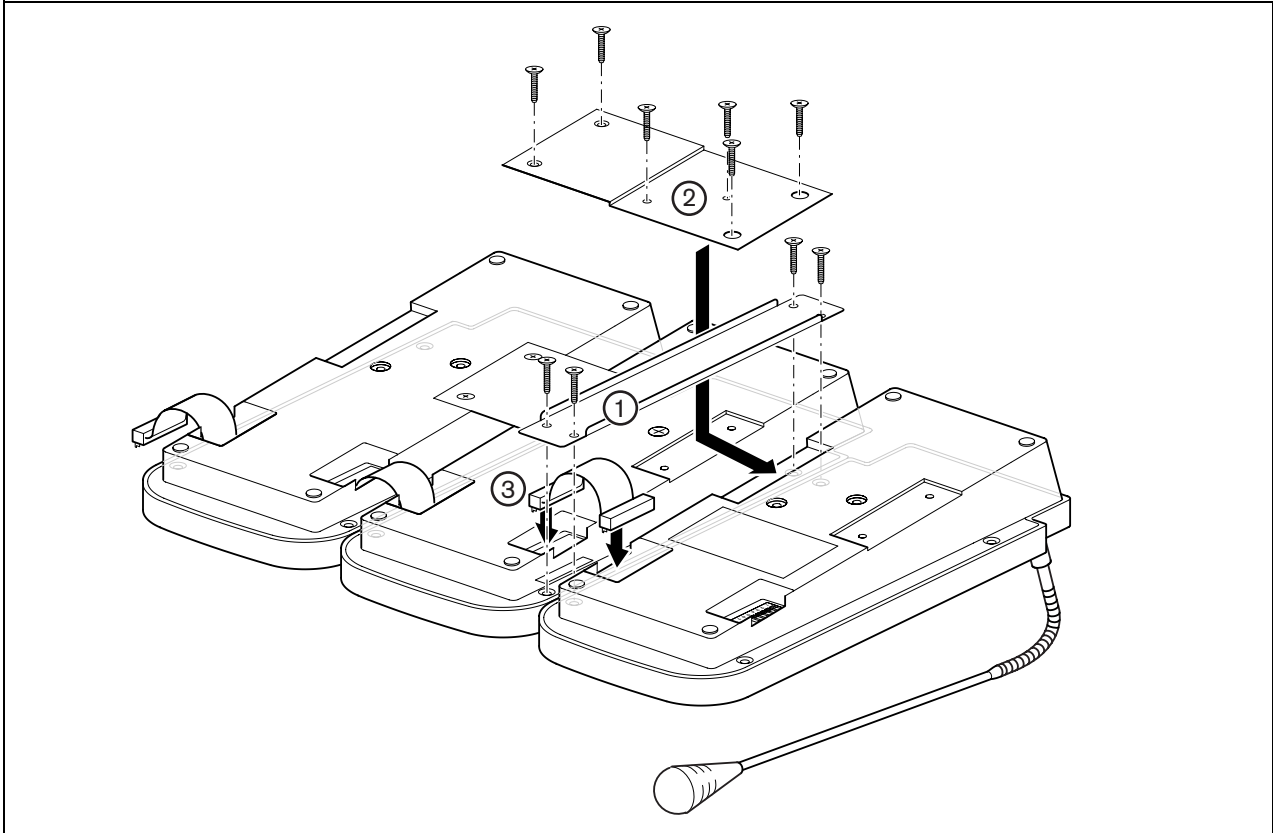

figure 8.2: Connecting call station keypads

## 8.3 Technical data

**EMC emission:**

According to EN55103-1

**EMC immunity:**

According to EN55103-2

**Dimensions:**

40 x 100 x 235 (base)

## 9 LBB1996/00 Voice Alarm Remote Control

### 9.1 Controls, connectors and indicators

See figure 9.1 for an overview of the controls, connections and indicators on the remote control.

- 1 **Power LED/VU Meter** - A combined power indicator and VU meter. The green power LED is lit if the remote control is connected to the power supply. The VU meter indicates the call level: 0 dB (red), -6 dB, -20 dB (yellow).
- 2 **Fault indicators** - Twelve yellow system fault LEDs (Processor reset, Network, Call/EMG, Music/Spare, Ground short, Input, Mains, Battery, Message, EMG mic, RCP and Router) and twelve yellow loudspeaker line fault LEDs. Fault indication is only possible if supervision is enabled (see section 28.4). If supervision is disabled, the yellow Disabled LED is lit.
- 3 **Fault state buttons** - Two buttons to acknowledge (Ack) and reset (Reset) the fault state (see 28).
- 4 **Emergency state buttons** - Two buttons to acknowledge (Ack) and reset (Reset) the emergency state (see 27).
- 5 **Emergency call zone selectors** - Six buttons to select the zones to which the emergency call must be distributed (see 27). Each button has a green and a red LED. The six red LEDs indicate the zones that are selected for the emergency call. The six green LEDs indicate the zones in which a business call is running.
- 6 **BGM zone selectors** - Six buttons to select the zones to which the BGM is distributed (see 25). Each button has a green LED. The six green LEDs indicate the zones to which BGM is distributed.
- 7 **All call button** - A button to select all zones. This button is only available in the emergency state (see 27).
- 8 **Indicator test button** - A button to test all LEDs on the front panel of the remote control and all connected remote control extensions. All LEDs are lit as long as the button is pushed (see 28).
- 9 **Emergency button** - A push button to put the system in the emergency state (see 27).
- 10 **Alert message button** - A button to select the alert message. This button is only available in the emergency state (see 27).
- 11 **Alarm message button** - A button to select the default alarm message. This button is only available in the emergency state (see 27).
- 12 **Microphone socket** - A socket to connect the hand-held emergency microphone (see section 5.3.1).
- 13 **Bracket** - A bracket for the hand-held emergency microphone that is supplied with the remote control.
- 14 **Monitoring speaker** - Built-in monitoring speaker.



#### Note

It is not possible to control the volume of the BGM with the remote control.

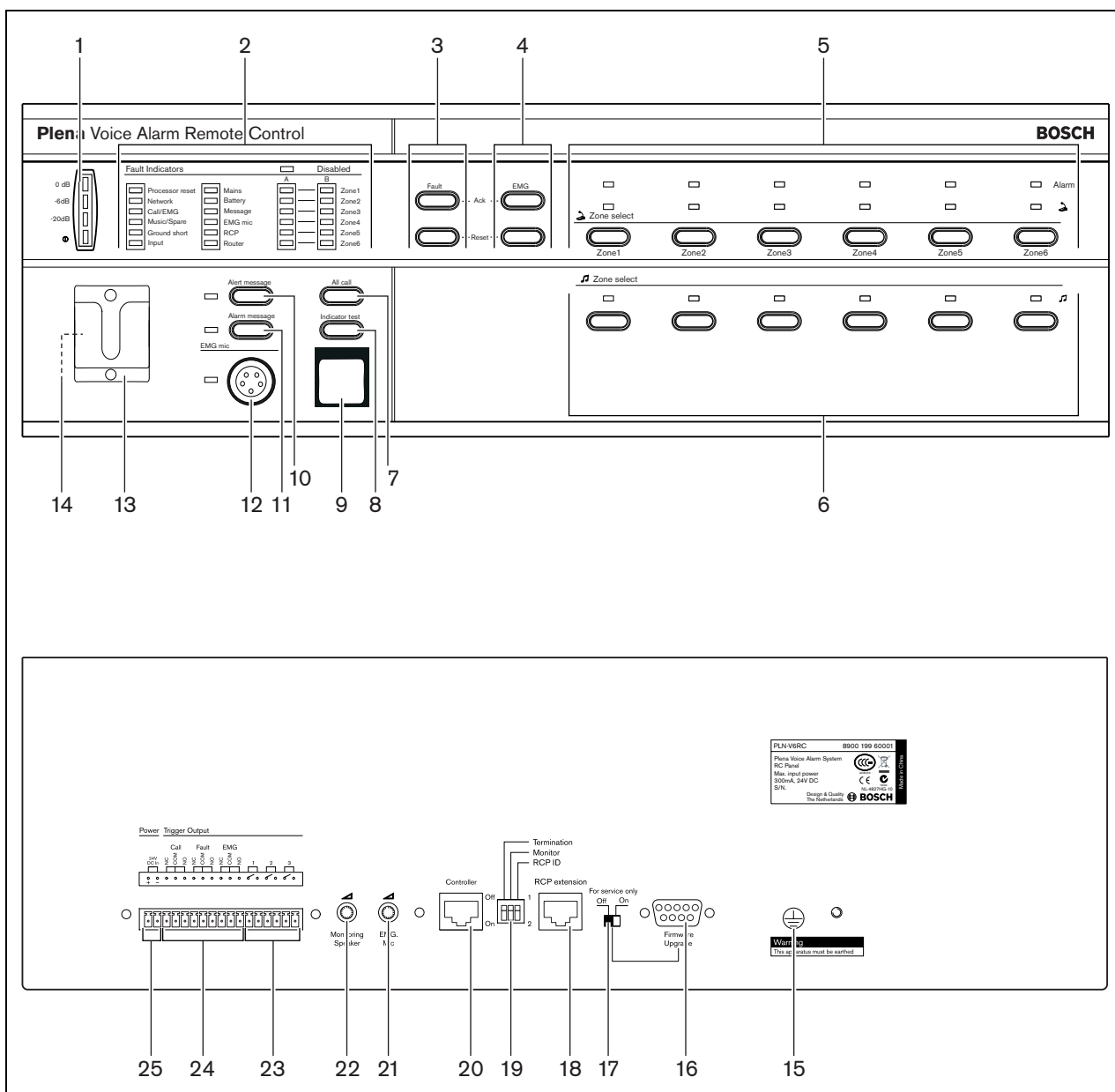

figure 9.1: Front and rear views of the voice alarm remote control

- 15 **Ground** - A connection to electrically ground the remote control.
- 16 **Firmware upgrade connector** - An RS232 connector to connect a PC to upgrade the firmware of the remote control.
- 17 **Firmware upgrade switch** - A switch to upgrade the firmware of the remote control.
- 18 **Remote control extension sockets** - Two redundant RJ45 sockets to connect remote control extensions to the remote control (see section 9.3.2).
- 19 **Configuration settings** - A set of DIP switches to configure the remote control (see 22).
- 20 **Controller socket** - One RJ45 socket to connect the remote control to the voice alarm controller (LBB1990/00, see section 9.3.1).
- 21 **Emergency microphone volume control** - A rotary knob to set the volume of the hand-held emergency microphone.

- 22 **Monitoring speaker volume control** - A rotary knob to set the volume of the monitoring loudspeaker.
- 23 **Trigger outputs** - Three general purpose trigger outputs. For future use.
- 24 **Status outputs** - Three status outputs to send the status of the Plena Voice Alarm System to third party equipment (see section 9.3.3).
- 25 **24 V DC input** - One 24 V(DC) input to connect the remote control panel to a power supply (see section 9.3.4).

## 9.2 Installation

The remote control is suitable for table-top and 19-inch rack mounting installation. Two brackets for rack-mounting are supplied. Installing a remote control is similar to installing a voice alarm controller (see section 5.2). The brackets can also be used to attach the remote control to a wall.

## 9.3 External connections

### 9.3.1 Voice alarm controller

Connect the remote control panel to the voice alarm controller (see section 5.3.5).

### 9.3.2 Remote control extensions

The remote control has 1 socket for remote control extensions (LBB1997/00, LBB1999/00). Use shielded Cat-5 Ethernet cables with RJ45 plugs to connect a remote control extension to the remote control. When the system requires more than 1 remote control extension, use the system sockets on the remote control extension to make loop-throughs. See figure 9.2 for connection details.

The termination switch must be set to ON. If not, over long distances, the data bus can mal-function.

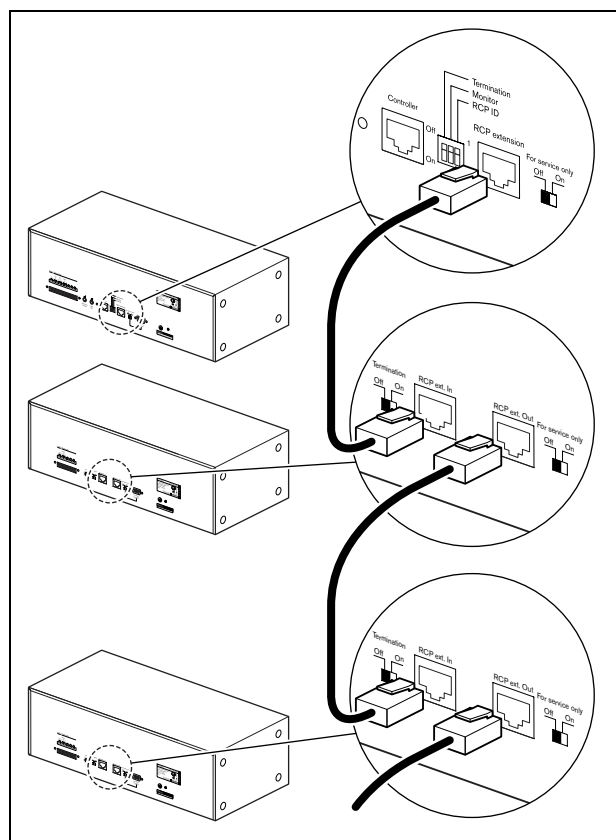

figure 9.2: Connecting remote control extensions

The remote control that is connected to CR1 must have the ID switch set to 1. The remote control that is connected to RC2 must have the ID switch set to 2.

### 9.3.3 Status output contacts

The remote control panel has 3 status output contacts to indicate the current system state. The procedure for connecting the status outputs is the same as the procedure for connecting status outputs to the voice alarm controller (see section 5.3.11).

### 9.3.4 Power

Connect a back-up power supply to the remote control panel (see figure 9.3).

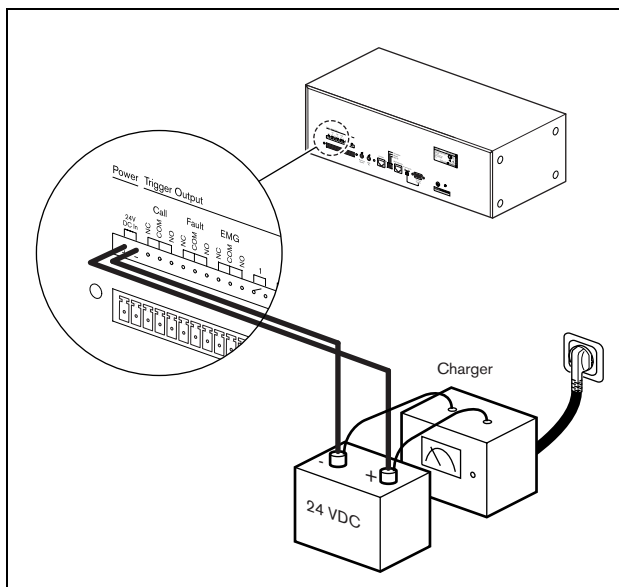

figure 9.3: Connecting a back-up power supply

## 9.4 Technical data

#### EMC emission:

According to EN55103-1

#### EMC immunity:

According to EN55103-2

#### Current consumption:

150 mA (typical), 24 V(DC)

400 mA (indicator test), 24 V(DC)

#### Dimensions:

132.5 x 430 x 90 mm

#### Weight:

2.2 kg

## 10 LBB1998/00 Voice Alarm Remote Control Kit

### 10.1 Introduction

With the LBB1998/00 Voice Alarm Remote Control Kit, it is possible to make customized remote controls that can be connected to the voice alarm controller. The remote control kit provides the same functionality as the LBB1996/00 Voice Alarm Remote Control.

### 10.2 Overview

See figure 10.1 for an overview of the front panel of the remote control kit. The rear panel of the remote control kit is the same as the rear panel of the LBB1996/00 Voice Alarm Remote Control (see figure 9.1).

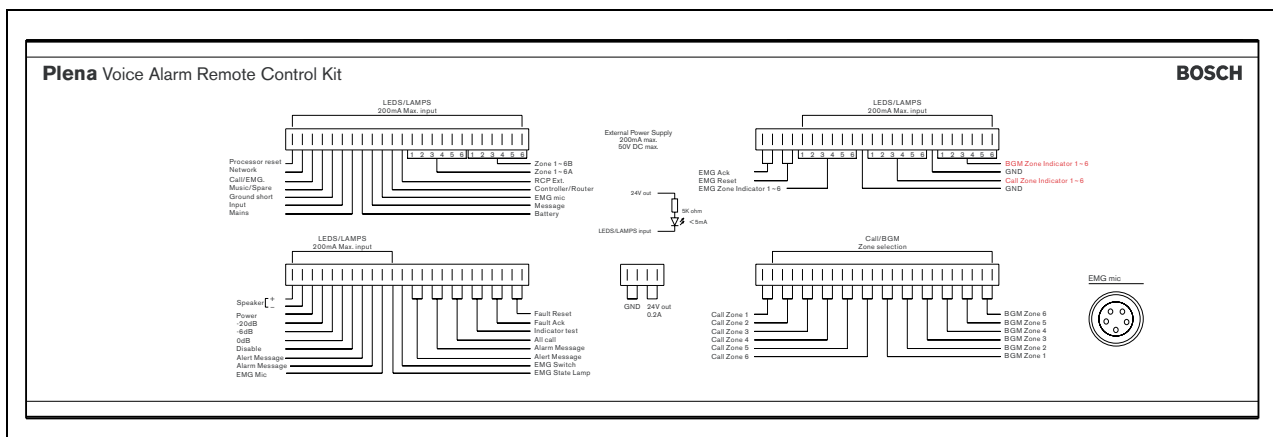

figure 10.1: Front and rear views of the remote control kit

### 10.3 Installation

The remote control kit is suitable for table-top and 19-inch rack mounting installation. Two brackets for rack-mounting are supplied. Installing a remote control kit is similar to installing a voice alarm controller (see section 5.2).

## 10.4 External connections

### 10.4.1 Rear panel

The rear panel of the remote control kit has the same connectors and controls as the rear panel of the LBB1996/00 Voice Alarm Remote Control. See section 9.3 for connection details.

### 10.4.2 LEDs

To the LEDS/LAMPS connectors on the front panel of the remote control kit, the LEDs can be connected (see figure 10.2).

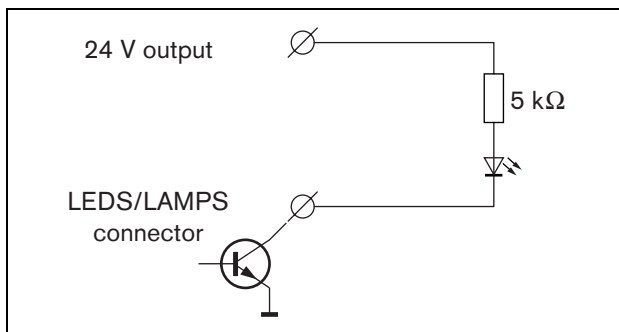

figure 10.2: Connecting LEDs

### 10.4.3 Lamps

To the LEDS/LAMPS connectors on the front panel of the remote control kit, lamps can be connected (see figure 10.3).

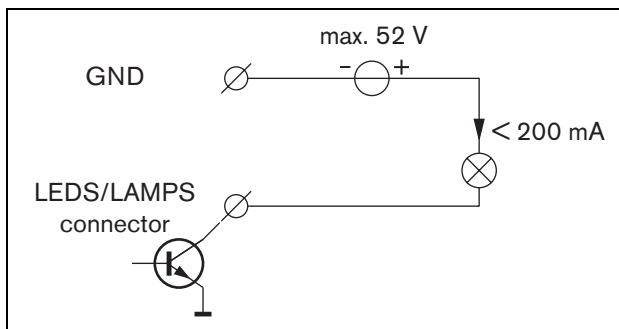

figure 10.3: Connecting lamps

### 10.4.4 Relays

To the LEDS/LAMPS connectors on the front panel of the remote control kit, relays can be connected (see figure 10.4).

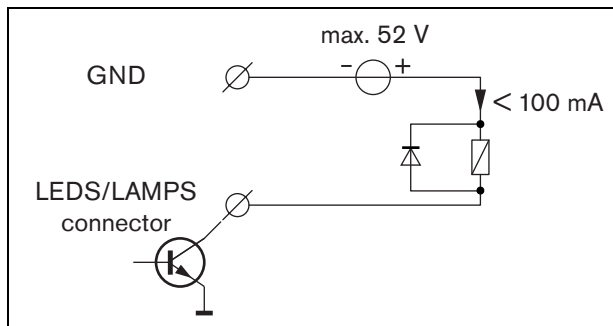

figure 10.4: Connecting relays

## 10.5 Technical data

### EMC emission:

According to EN55103-1

### EMC immunity:

According to EN55103-2

### Current consumption:

150 mA (idle)

400 mA (indicator test)

### Dimensions:

132.5 x 430 x 90 mm

### Weight:

2.2 kg

# 11 LBB1997/00 Remote Control Extension

## 11.1 Controls, connectors and indicators

See figure 11.1 for an overview of the controls, indicators and connectors on the remote control extension:

- 1 **Power LED/VU Meter** - A combined power indicator and VU meter. The green power LED is lit if the remote control extension is connected to the mains or back-up power and switched on. The VU meter indicates the call level: 0 dB (red), -6 dB, -20 dB (yellow).

- 2 **Fault indicators** - Eight yellow system fault LEDs (Processor reset, Network, Call/EMG, Music/Spare, Ground short, Input, Mains, Battery) and twelve yellow loudspeaker line fault LEDs. Fault indication is only possible if supervision is enabled (see section 28.4).
- 3 **Emergency call zone selectors** - Six buttons to select the zones to which the emergency call must be distributed (see 27). Each button has a green and a red LED. The six red LEDs indicate the zones that are selected for the emergency call. The six green LEDs indicate the zones in which a business call is running.
- 4 **BGM zone selectors** - Six buttons to select the zones to which the BGM is distributed (see 25). Each button has a green LED. The six green LEDs indicate the zones to which BGM is distributed.

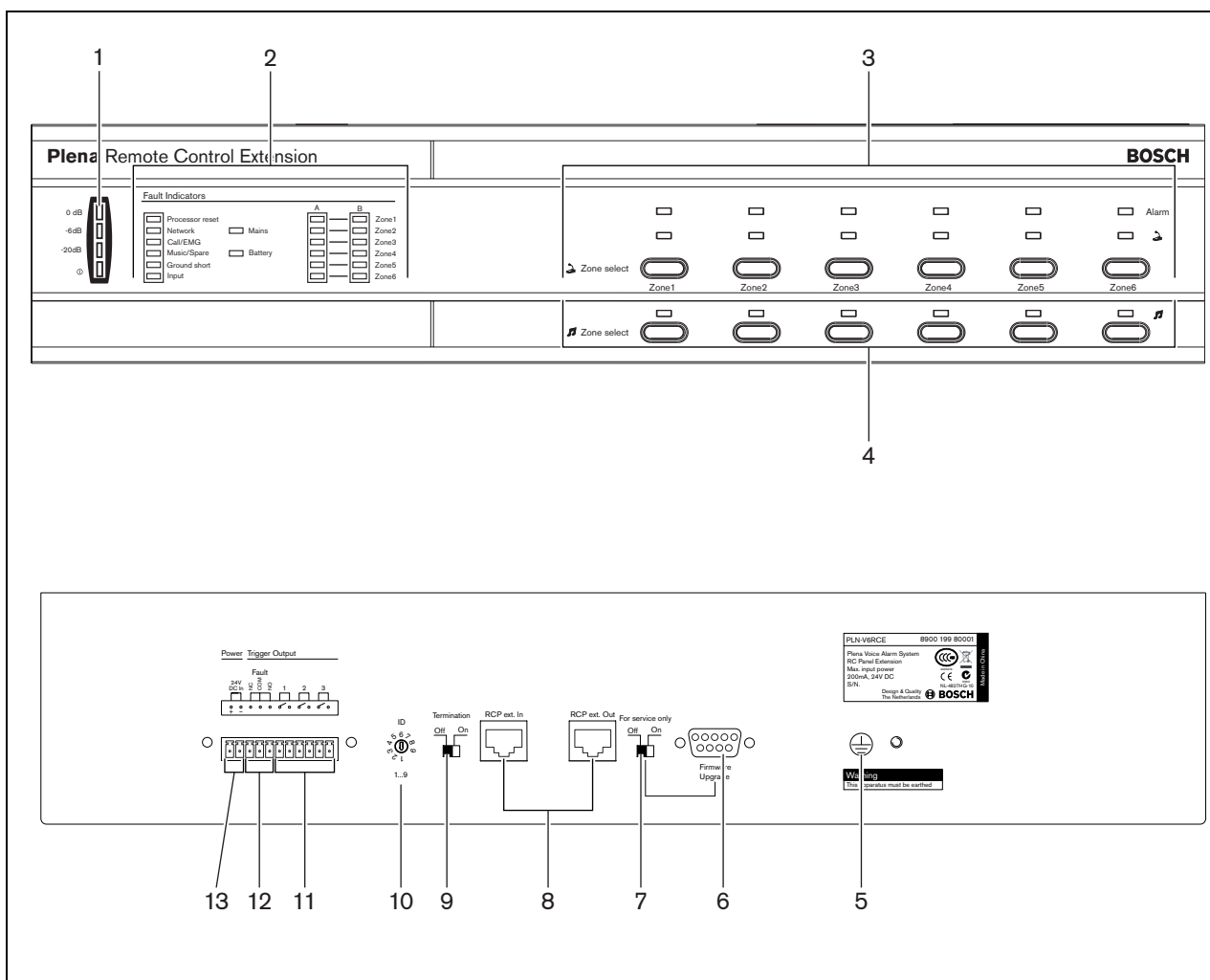

figure 11.1: Front and rear views of the remote control extension kit

- 5 **Ground** - A connection to electrically ground the remote control extension.
- 6 **Firmware upgrade connector** - An RS232 connector to connect a PC to upgrade the firmware of the remote control extension.
- 7 **Firmware upgrade switch** - A switch to upgrade the firmware of the remote control extension.
- 8 **System sockets** - Two redundant RJ45 sockets to connect the remote control extension to the remote control (see section 9.3.2).
- 9 **Configuration settings** - A set of DIP switches to configure the voice alarm router (see 23).
- 10 **Remote control extension ID** - A rotary switch to set the ID of the remote control extension (see 23).
- 11 **Trigger outputs** - Three general purpose trigger outputs. For future use.
- 12 **Status output** - One status output to send the status of the Plena Voice Alarm System to third party equipment (see section 11.3.2).
- 13 **24 V DC input** - One 24 V(DC) input to connect the remote control panel to a power supply (see section 11.3.3).

## 11.2 Installation

The remote control extension is suitable for table-top and 19-inch rack mounting installation. Two brackets for rack-mounting are supplied. Installing a remote control extension is similar to installing a voice alarm controller (see section 5.2). The brackets can also be used to attach the remote control extension to a wall.

## 11.3 External connections

### 11.3.1 Remote control

Connect the remote control extension to the remote control (see section 9.3.2).

### 11.3.2 Status output contacts

The remote control extension has 1 status output contacts to indicate the current system state. The procedure for connecting the status outputs is the same as the procedure for connecting status outputs to the voice alarm controller (see section 5.3.11).

### 11.3.3 Power

Connect a back-up power supply to the remote control extension (see figure 11.2).

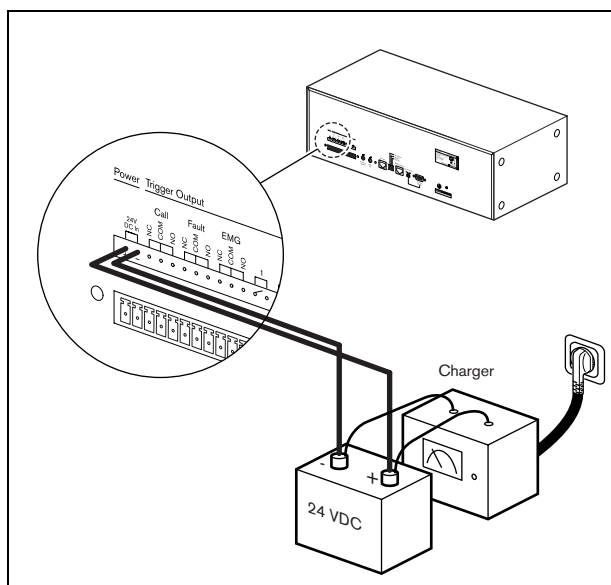

figure 11.2: Connecting a power supply

## 11.4 Technical data

<b>EMC emission:</b>
According to EN55103-1
<b>EMC immunity:</b>
According to EN55103-2
<b>Current consumption:</b>
50 mA (idle)
200 mA (indicator test)
<b>Dimensions:</b>
88 x 432 x 90 mm
<b>Weight:</b>
1.8 kg

## 12 LBB1999/00 Remote Control Extension Kit

### 12.1 Introduction

With the LBB1999/00 Voice Alarm Control Extension Kit, it is possible to make customized remote control extensions that can be connected to a remote control (LBB1995/00, LBB1996/00, LBB1998/00). The remote control extension kit provides the same functionality as the LBB1997/00 Voice Alarm Remote Control Extension.

### 12.2 Overview

See figure 12.1 for an overview of the front panel of the remote control extension kit. The rear panel of the remote control extension kit is the same as the rear panel of the LBB1997/00 Voice Alarm Remote Control Extension (see figure 11.1).

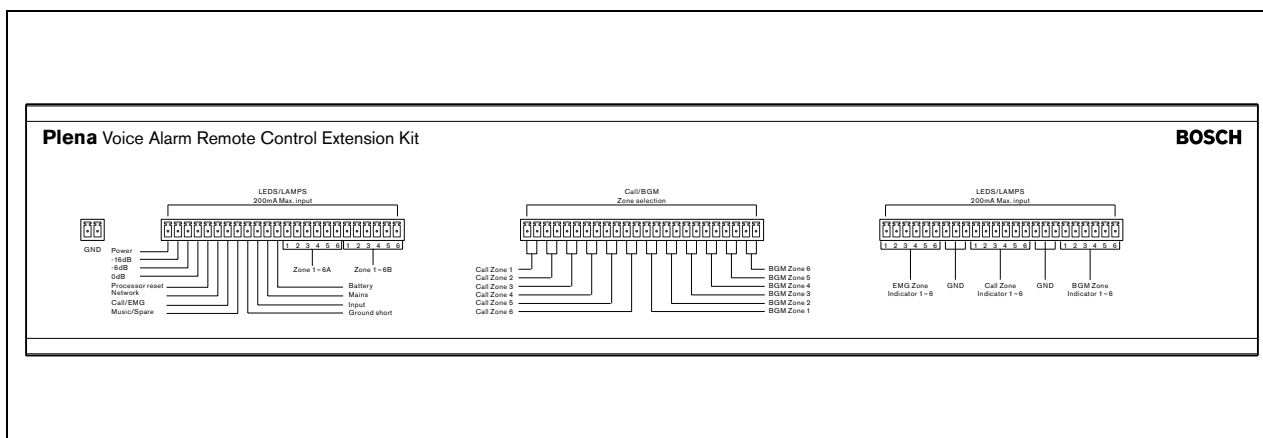

figure 12.1: Front and rear views of the remote control extension kit

### 12.3 Installation

The remote control extension kit is suitable for table-top and 19-inch rack mounting installation. Two brackets for rack-mounting are supplied. Installing a remote control kit is similar to installing a voice alarm controller (see section 5.2).

## 12.4 External connections

### 12.4.1 Rear panel

The rear panel of the remote control extension kit has the same connectors and controls as the rear panel of the LBB1997/00 Voice Alarm Control Extension. See section 11.3 for connection details.

### 12.4.2 LEDs

To the LEDS/LAMPS connectors on the front panel of the remote control extension kit, the LEDs can be connected (see figure 10.2).

### 12.4.3 Lamps

To the LEDS/LAMPS connectors on the front panel of the remote control extension kit, lamps can be connected (see figure 10.3).

### 12.4.4 Relays

To the LEDS/LAMPS connectors on the front panel of the remote control extension kit, relays can be connected (see figure 10.4).

## 12.5 Technical data

<b>EMC emission:</b>
According to EN55103-1
<b>EMC immunity:</b>
According to EN55103-2
<b>Current consumption:</b>
50 mA (idle)
200 mA (indicator test)
<b>Dimensions:</b>
88 x 432 x 90 mm
<b>Weight:</b>
1.8 kg

## 13 LBB1995/00 Fireman's Panel

### 13.1 Controls, connectors and indicators

See figure 13.1 for an overview of the controls, connections and indicators on the fireman's panel:

- 1 **Power LED/VU Meter** - A combined power indicator and VU meter. The green power LED is lit if the fireman's panel is connected to the power supply. The VU meter indicates the call level: 0 dB (red), -6 dB, -20 dB (yellow).
- 2 **Emergency button** - A push button to put the system in the emergency state (see 27).
- 3 **Emergency acknowledge** - A push button to acknowledge the emergency state (see 27).
- 4 **Emergency reset** - A push button to reset the emergency state (see 27).
- 5 **Alarm message button** - A push button to start the default alarm message. This button is only available in the emergency state (see 27).
- 6 **Fault acknowledge** - A push button to acknowledge the fault state (28).
- 7 **Fault reset** - A push button to reset the fault state (see 28).
- 8 **Fault indicators** - Twelve yellow system fault LEDs (Processor reset, Network, Call/EMG, Music/Spare, Ground short, Input, Mains, Battery, Message, EMG mic, RCP and Router) and twelve yellow loudspeaker line fault LEDs. Fault indication is only possible if supervision is enabled (see section 28.4). If supervision is disabled, the yellow Disabled LED is lit.
- 9 **Indicator test button** - A button to test all LEDs on the front panel of the fireman's panel and all connected remote control extensions. All LEDs are lit as long as the button is pushed (see 28).
- 10 **Ground** - A connection to electrically ground the fireman's panel.
- 11 **Firmware upgrade connector** - An RS232 connector to connect a PC to upgrade the firmware of the fireman's panel.
- 12 **Firmware upgrade switch** - A switch to upgrade the firmware of the fireman's panel.
- 13 **Remote control extension sockets** - Two redundant RJ45 sockets to connect remote control extensions to the fireman's panel (see section 9.3.2).
- 14 **Configuration settings** - A set of DIP switches to configure the fireman's panel (see 22).
- 15 **Controller socket** - One RJ45 socket to connect the fireman's panel to the voice alarm controller (LBB1990/00, see section 9.3.1).
- 16 **Emergency microphone volume control** - A rotary knob to set the volume of the hand-held emergency microphone.
- 17 **Monitoring speaker volume control** - A rotary knob to set the volume of the monitoring loudspeaker.
- 18 **Trigger outputs** - Three general purpose trigger outputs. For future use.
- 19 **Status outputs** - Three status outputs to send the status of the Plena Voice Alarm System to third party equipment (see section 13.2.3).
- 20 **24 V DC input** - One 24 V(DC) input to connect the fireman's panel to a power supply (see section 13.2.4).

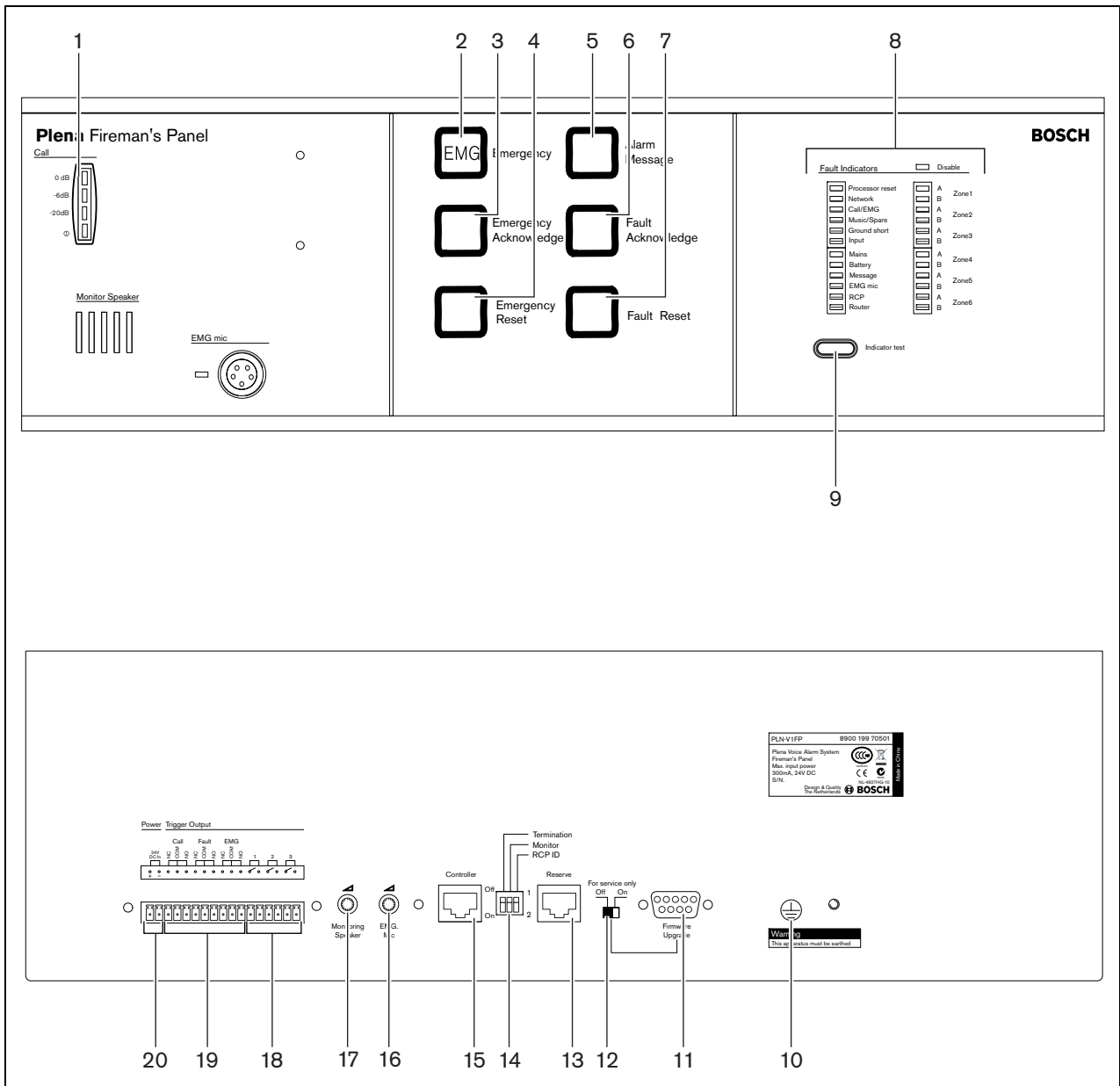

figure 13.1: Front and rear views of the fireman's panel

## 13.2 External connections

### 13.2.1 Voice alarm controller

Connect the fireman's panel to the voice alarm controller (see section 5.3.5).

### 13.2.2 Remote control extensions

The remote controller has 1 socket for remote control extensions (LBB1997/00, LBB1999/00). Use shielded Cat-5 Ethernet cables with RJ45 plugs to connect a remote control extension to the remote control. When the system requires more than 1 remote control extension, use the system sockets on the remote control extension to make loop-throughs. See section 9.3.2 for connection details.

### 13.2.3 Status output contacts

The remote control panel has 3 status output contacts to indicate the current system state. The procedure for connecting the status outputs is the same as the procedure for connecting status outputs to the voice alarm controller (see section 5.3.11).

### 13.2.4 Power

The procedure for connecting a fireman's panel to a power supply is the same as the procedure for connecting a remote control to a power supply (see section 9.3.4).

## 13.3 Technical data

<b>EMC emission:</b> According to EN55103-1
<b>EMC immunity:</b> According to EN55103-2
<b>Current consumption:</b> 150 mA (idle) 400 mA (indicator test)
<b>Dimensions:</b> 132.5 x 430 x 90 mm
<b>Weight:</b> 2.2 kg

## 14 End of line detection

### 14.1 Introduction

The End Of Line (EOL) detection board makes a continuous check of the integrity of the loudspeaker line based on a pilot tone. This check is in addition to the check given by the impedance measurement. The pilot tone is independent of the quantity of the loudspeakers in the system or the load on the speaker cables.

### 14.2 Overview

The EOL is installed in the speaker cabinet at the furthest point on a loudspeaker line. When the EOL detects a pilot tone that is given by the voice alarm system, the loudspeaker lines have no fault. The EOL trigger output is closed and the LED lights up to show that the lines have a pilot tone signal.

If the loudspeaker cable has a fault, the pilot tone stops. The EOL circuit becomes open, which is detected by the Voice Alarm Controller.

One EOL board can be installed to give a single fault indication per zone or more than one can be installed on a single fault input to check the integrity of a loudspeaker line with several branches. When more than one EOL board is installed, the configuration is called a daisy-chain.

When a fault is detected by the VAC, to find the EOL board that detects the failure, every individual board must be checked.

### 14.3 Installation

To install an EOL, use these general notes.

- An EOL board can only be installed in a 2-channel system. The EOL board needs the second amplifier to produce the pilot tone for the zones that are not in use. Refer to 17.5.3.
- The volume control on the VAC must be set to -9 dB or higher. The recommended setting is 0 dB. A lower dB setting attenuates the pilot tone.



#### Note

Do not connect the EOL board to the secondary side of a volume control. The secondary side of a volume control can attenuate the pilot tone.

- All inputs to a VAC or router that have an EOL input must be normally closed inputs. The EOL board operates with a normally closed output and the configuration software is set to Action Open. Use another router to receive normally open inputs.



#### Note

During a call the pilot tone is absent in zones without a call or without background music. The red LED on the EOL board is dim. The EOL input is ignored during calls to avoid false fault readings.

- The Short circuit check must be set in the configuration software.



#### Note

The EOL board detects a short circuit, but the EOL cannot detect where the short circuit is.



#### Note

It is possible for the LED will to turn off before the contact is opened or vice versa. This level difference is typically less than 500 mV.

### 14.3.1 Installation of a single EOL

- 1 Connect the two cables at the end of the 100 V loudspeaker line to the Input 100V LS on the EOL board.
- 2 Connect the two cables from an Emergency Trigger Input on the Voice Alarm Controller to TRGA on the EOL.
- 3 Connect the jumpers JP1 on the EOL as shown.

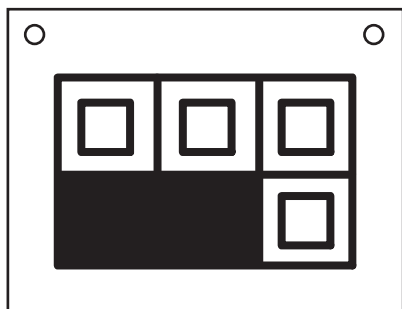

figure 14.1 JP1 for single EOL

### 14.3.2 Installation of multiple EOLs in a daisy-chain

With a daisy chain configuration it is possible to:

- Supervise several loudspeaker lines with only one fault input.
  - Supervise several branches of a loudspeaker line with just one fault input.
- 1 Connect the cable from the 100 V loudspeaker line to the terminal 100 V LS Input on the EOL board.
  - 2 Connect one cable from an Emergency Trigger Input on the Voice Alarm Controller to the FIRST BOARD input on the EOL board.

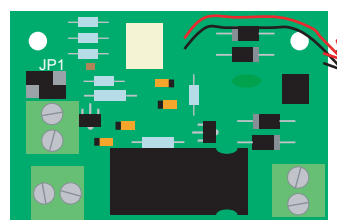

figure 14.2 JP1 for first EOL

- 3 Connect a 20 or 22 k $\Omega$  resistor in parallel with the Trigger input to connect more than one EOL board on a single Trigger input and to supervise them.
- 4 Connect the EOL boards to the Trigger input as indicated in figure 14.3. This input should be on the Controller or Router to which the loudspeaker lines it supervises are also connected.



#### Note

The last EOL board in line is connected in a different way than the other EOL boards. This is required to supervise the whole EOL detection line against short circuit. Such a short circuit will be reported as an Input Fault. A break in the detection line will be reported as a Line Fault, just as a loudspeaker line failure.

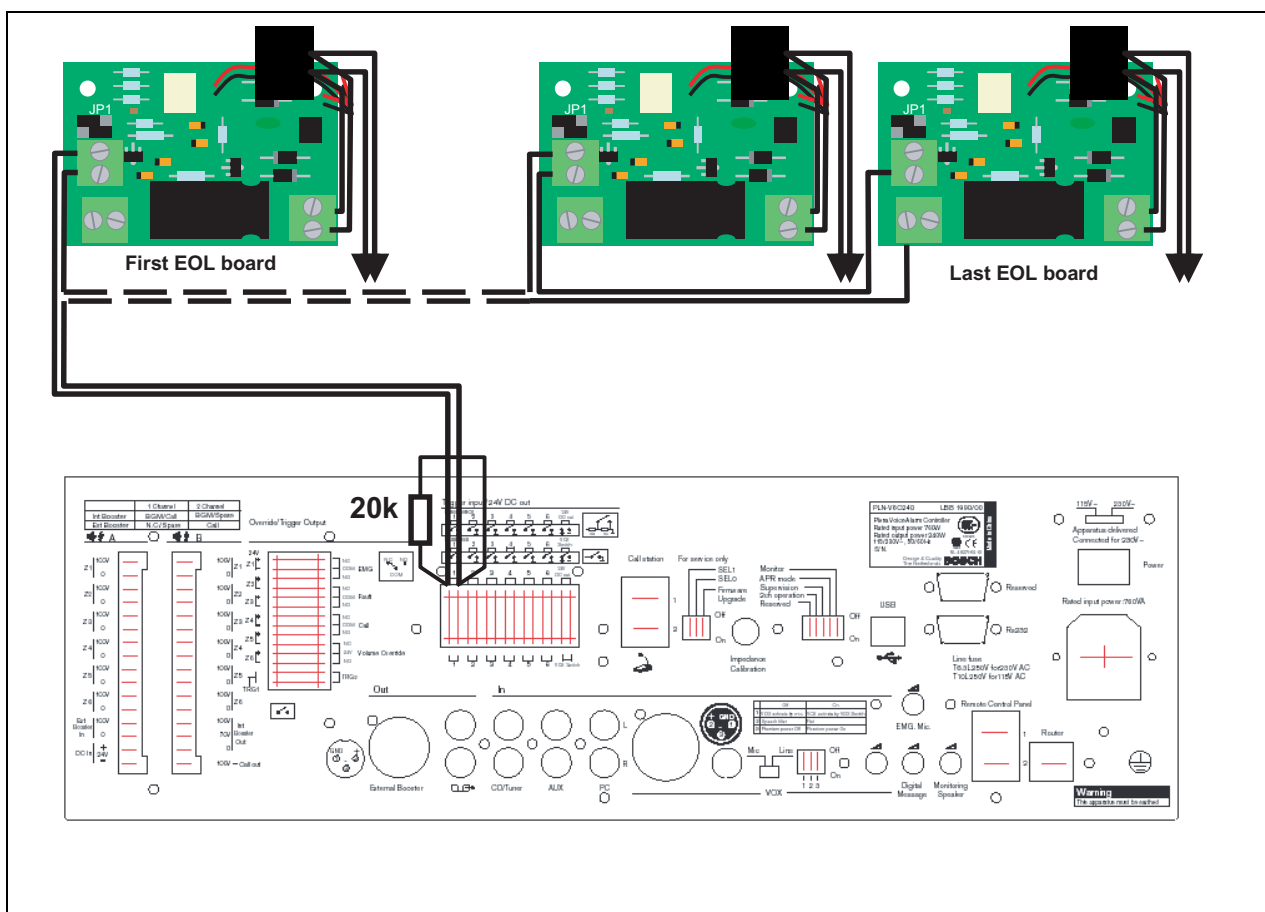

figure 14.3: Trigger input indication

- 5 In the configuration program, set the Action Programming for the relevant input to Fault and EOL.
- 6 Enter the Zone or Zone group that is monitored by the EOL board. The Zone group can be All Zones (of the Controller/Router), Zone 1-3 or Zone 4-6. Fault Type and Zone will define the visual indication on the unit in case of a fault.
- 7 Set the Action to Open and Type to Momentary. See figure 14.4 for an example.

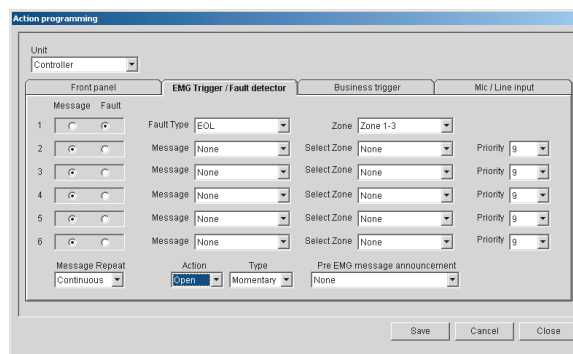

figure 14.4 Action programming window in configuration program.

## 14.4 Technical data

<b>Input level:</b>
100 V rms @ program 20 Hz - 20 kHz
<b>Pilot input level:</b>
5 V - 50 V @ 20 kHz $\pm$ 20%
<b>Minimum trigger level:</b>
3.5 V
<b>Output:</b>
floating single trigger
<b>Isolation:</b>
250 Vp
<b>Max level on open contact</b>
250 VDC
<b>Response time</b>
close min 1 second
<b>Response time</b>
close max 10 seconds

## 15 Dummy load

### 15.1 Introduction

The Dummy Load has these functions:

- Increases the percentage of impedance (with respect to the cable impedance) present at the end of the line.
- Allows more loudspeakers to be fitted.
- Allows longer cable lengths.

Fault detection of the loudspeaker lines with impedance measurement is triggered by a change in excess of 20%. The impedance at the end of the loudspeaker line must be more than 20% of the total impedance to make sure that an open circuit is detected.

The Dummy Load has a jumper to set the load at 20 kHz to 8, 20 and 60 W.

### 15.2 Set the jumper JP1 on the Dummy load

**Note**

You can find the Dummyload calculator.xls on the Plena Voice Alarm CD.

**Note**

In some loudspeakers only one mounting stud is available as the studs are too far apart.

- 1 Use the Dummy Load Calculator to calculate the jumper setting of JP1 on the Dummy load.
- 2 Select the Excel sheet Dummyload calculator. Click on Enable Macros when the dialog box appears. The worksheet opens.
- 3 Type the load per loudspeaker in Step 1. The maximum number of loudspeakers is automatically calculated and appears in Step 2.
- 4 Type the number of loudspeakers in the line in Step 2. The result automatically appears in Step 3.
- 5 Type the capacitance of the 100 V cable in Step 4.
- 6 Type the length of the cable in Step 5.
- 7 Click Display jumper JP1 settings. The configuration of the jumper settings appears.
- 8 Set the jumper JP1 on the Dummy load to the shown in the calculator.

### 15.3 Installation

To install the Dummy load do as follows:

- 1 Connect the two leads onto the connection terminals of the last loudspeaker in a line.
- 2 Attach the Dummy Load circuit board in the loudspeaker cabinet to the mounting studs.

Intentionally left blank.

## Section 3 - Configuration

## 16 Introduction

A number of functions of the Plena Voice Alarm System is hardware configured using, for example, DIP switches and volume controls. Other parts of the system must be software configured using the Plena Voice Alarm System configuration software. A description of this software is beyond the scope of the Installation and User Instructions. The Installation and User Instructions only describe the hardware configuration of a Plena Voice Alarm System.

**Note**

See the Configuration Software Manual (9922 141 1038x) for more information about the configuration software.

It is recommended to do the hardware configuration of the system before the software configuration.

## 17 System settings

### 17.1 Introduction

The system settings are configured using DIP switches on the rear of the voice alarm controller (see figure 17.1). By default, all switches are in the OFF position.

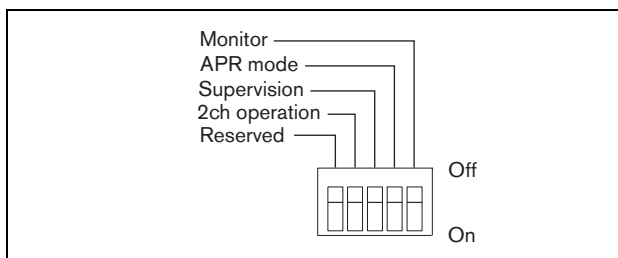

figure 17.1: System settings DIP switches

table 17.1: System settings DIP switches

DIP switch	Description
Monitor	Switches the monitoring loudspeaker on (ON) and off (OFF). See section 17.2.
APR mode	Switches the Asian Pacific Region mode on (ON) and off (OFF). See section 17.3.
Supervision	Switches supervision on (ON) and off (OFF). See section 17.4.
2ch operation	Switches 2-channel operation on (ON) and off (OFF). See section 17.5.
Reserved	Reserved. This DIP switch must always be in the OFF position.

### 17.2 Monitor

If the Monitor switch (see figure 17.1) is in the ON position, the internal monitoring loudspeaker of the voice alarm controller is switched on. The volume of the monitoring loudspeaker is set with the Monitoring Speaker volume control (see figure 5.1, no. 36).

### 17.3 APR mode

If the APR mode switch (see figure 17.1) is in the ON position, the system is in the Asian-Pacific Region (APR) mode. In APR mode, the system operates according to the emergency standards of the Asian-Pacific Region. In the APR mode:

- The priority level of the emergency trigger inputs is always 14.
- Emergency and business trigger inputs of the same zone form pairs. The settings of the emergency trigger input (software configurable) apply to both.
- The emergency trigger inputs are never supervised.
- When an emergency trigger input is activated, the system enters the emergency state. The voice alarm controller also automatically starts a pre-emergency announcement and alarm message (software configurable).
- When a business trigger input is activated, the system enters the emergency state. The voice alarm controller does not automatically start a pre-emergency announcement and alarm message.
- The red LED, which during normal operation indicates that the zone is selected for an emergency call (see figure 5.1, no. 5), indicates that an emergency trigger input is active.
- The green LED, which during normal operation indicates that a business call is running in the zone (see figure 5.1, no. 5), indicates that an emergency call is running in the zone.
- The priority level of the emergency microphone of the voice alarm controller is always 16.
- When the emergency button (see figure 5.1, no. 12) is pushed on the front of the voice alarm controller, an alarm message is automatically started. This message is automatically repeated.

## 17.4 Supervision

If the Supervision switch (see figure 17.1) is in the ON position, supervision is enabled. If it is in the OFF position, supervision is disabled. See chapter 18 for more information about supervision.

## 17.5 1 channel and 2 channel operation

### 17.5.1 Introduction

If the 2ch operation switch (see figure 17.1) is in the ON position, the system operates in the 2-channel mode. If the 2ch operation switch is in the OFF position, the system operates in the 1-channel mode.

### 17.5.2 1-channel mode

#### 17.5.2.1 Voice alarm controller

In the 1-channel mode, all calls and BGM are amplified by the internal power amplifier of the voice alarm controller. If desired, an external power amplifier can be connected for spare switching (see section 5.3.4). In 1-channel mode, all calls will interrupt the BGM.

table 17.2: 1-channel mode, voice alarm controller

Amplifier	Function
Internal	BGM/Call power amplifier
External	Not connected/Spare power amplifier

#### 17.5.2.2 Voice alarm router

One or two external power amplifiers can be connected to a voice alarm router to increase the power of the system (see section 5.3.4). In 1-channel mode:

- External power amplifier 1 of the voice alarm router is used to help the internal power amplifier of the voice alarm controller to amplify calls and BGM.
- External power amplifier 2 of the voice alarm router is used for spare-switching.

table 17.3: 1-channel mode, voice alarm router

Amplifier	Function
1	BGM/Call power amplifier
2	Not connected/Spare power amplifier

### 17.5.3 2-channel mode

#### 17.5.3.1 Voice alarm controller

In the 2-channel mode, the BGM is amplified by the internal power amplifier of the voice alarm controller. The calls are amplified by the external power amplifier, which is connected to the voice alarm controller (see section 5.3.4). If the external power amplifier is faulty, the calls are amplified by the internal power amplifier. In 2-channel mode, calls do not interrupt the BGM.

table 17.4: 2-channel mode, controller

Amplifier	Function
Internal	BGM/Spare power amplifier
External	Call power amplifier

#### 17.5.3.2 Voice alarm router

One or two external power amplifiers can be connected to a voice alarm router to increase the power of the system (see section 5.3.4). In 2-channel mode:

- External power amplifier 1 of the voice alarm router is used to help the internal power amplifier of the voice alarm controller
- External power amplifier 2 of the voice alarm router is used to help the external power amplifier of the voice alarm controller to amplify calls.

table 17.5: 2-channel mode, router

Amplifier	Function
1	BGM/Spare power amplifier
2	Call power amplifier

## 18 Supervision

### 18.1 Introduction

If the Supervision switch (see figure 17.1) is in the ON position, supervision is enabled. If it is in the OFF position, supervision is disabled.



#### Note

Supervision is only necessary for systems that have to comply to the IEC60849 evacuation standard. If the system does not have to comply to this standard, leave the switch in the OFF position.

If the Supervision switch is in the OFF position, the Disabled indicator on the front panel of the voice alarm controller is lit (see figure 18.1) to indicate that supervision is switched off.

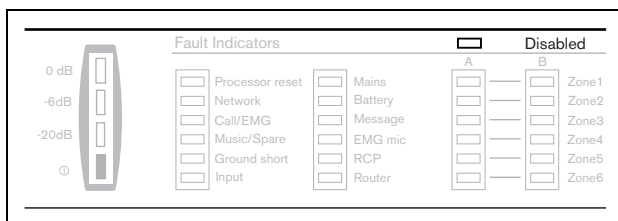

figure 18.1: Disabled indicator

If the Supervision switch is in the ON position, an indicator is lit when a supervised function fails (see chapter 28). Use the configuration software to switch supervised functions on and off.



#### Note

See the Configuration Software Manual (9922 141 1038x) for more information about the configuration software.

### 18.2 Processor reset

#### 18.2.1 Watchdog

If supervision is enabled (see section 18.1), the processor of the voice alarm controller is supervised by a watchdog. If the watchdog triggers, the Processor reset indicator on the front panel of the voice alarm controller is lit. Then, the program memory is checked and the processor resumes operation within 10 seconds. The indicator remains on until the fault is acknowledged and reset.

#### 18.2.2 New firmware

A processor reset sometimes happens after new firmware is installed. make sure the Service PID switches are put back to the correct position. The correct positions are:

- SEL0 and SEL1 to ON
- Enable Firmware Download to OFF.

### 18.3 Network

If supervision is enabled and network supervision is switched on (see section 18.1), the connections from the voice alarm controller to the voice alarm routers and remote controls are supervised. When any voice alarm router or remote control is missing during a network check, a network error is reported.

### 18.4 Power amplifiers

If supervision is enabled and call power amplifier supervision is switched on (see section 18.1), the call power amplifiers in the system are supervised. If supervision is enabled and BGM/Spare power amplifier supervision is switched on (see section 18.1), the BGM and spare power amplifiers in the system are supervised.

## 18.5 Ground short

If supervision is enabled and ground short supervision is switched on (see section 18.1), the system can continuously monitor loudspeaker lines in the system for short-to-ground situations. For each loudspeaker line, short-to-ground supervision can be switched on and off with the configuration software.



### Note

See the Configuration Software Manual (9922 141 1038x) for more information about the configuration software.

If a leakage current  $> 30 \pm 15$  mA is detected in a line, the line is considered faulty.

## 18.6 Emergency trigger inputs

If supervision is enabled and input supervision is switched on (see section 18.1), the system can supervise the emergency trigger inputs. For each emergency trigger input, supervision can be switched on and off with the configuration software.



### Note

See the Configuration Software Manual (9922 141 1038x) for more information about the configuration software.

## 18.7 Mains power

If supervision is enabled and mains power supervision is switched on (see section 18.1), the availability of the mains power is supervised.

## 18.8 Battery

If supervision is enabled and battery supervision is switched on (see section 18.1), the availability of the back-up power is supervised.

## 18.9 Message supervision

If supervision is enabled and message supervision is switched on (see section 18.1), the internal message manager of the voice alarm controller is supervised. This message supervision consists of supervision of the wave player using a check-sum and supervision of the audio path using a pilot tone.

## 18.10 Emergency microphone

If supervision is enabled and emergency microphone supervision is switched on (see section 18.1), the audio path and the PTT switch of the emergency microphone are monitored from the capsule to the connection with the voice alarm controller.

## 18.11 Line supervision

### 18.11.1 Introduction

If supervision is enabled and line supervision (see section 18.1) is switched on, all loudspeaker lines are supervised. Line supervision consists of:

- Impedance supervision (see section 18.11.2).
- Short-to-ground supervision (see section 18.11.3).

### 18.11.2 Impedance supervision

If line supervision is switched on, the voice alarm controller measures the impedance of all loudspeaker lines once every 90 seconds (default value). The reference values for impedance supervision are stored in the voice alarm controller during the system calibration (see section 24.3). If a difference of  $> 15\%$  (default value) is detected between the measured line impedance and its reference value, the line is considered faulty. The default values can be changed with the configuration software.



### Note

See the Configuration Software Manual (9922 141 1038x) for more information about the configuration software.



### Note

A small click can be heard at the start and end of an impedance measurement. If the click is unacceptable, then end of line supervision with EOL can be considered instead of impedance supervision.

### 18.11.3 Short-circuit supervision

If line supervision is switched on, the voice alarm controller continuously monitors all loudspeaker lines in the system for short-circuits.

If a short-circuit is detected, the line output of the short-circuited line is isolated and shut down within 200 ms. The system will remain operational. If the line is dual-redundant connected (A and B), the short-circuited line remains operational as well.

When a ground short occurs, first check the 0 V and 100 V connections from the amplifier to the Voice Alarm Controller. If these connections are incorrect, then a short fault can occur at unpredictable times.

## 19 Voice alarm controller

### 19.1 VOX configuration

#### 19.1.1 Introduction

The type of source that is connected to the mic/line input with VOX functionality is set using the Mic/Line switch on the rear of the voice alarm controller (see figure 19.1).

- If the source is a microphone, put the switch in the Mic position.
- If the source is a line-level source, put the switch in the Line position.



figure 19.1: VOX input source switch

The mic/line input with VOX functionality is configured using DIP switches on the rear of the voice alarm controller (see figure 19.2). By default, all switches are in the OFF position.

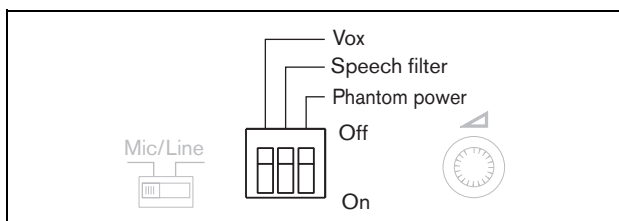

figure 19.2: VOX settings

The settings that can be made using the DIP switches are explained in a table on the rear of the voice alarm controller (see figure 19.3).

	Off	On
1	VOX activate by mic.	VOX activate by VOX Switch
2	Speech filter	Flat
3	Phantom power Off	Phantom power On

figure 19.3: VOX settings table

The volume of the mic/line input with VOX functionality is set with the VOX volume control (see figure 19.4).

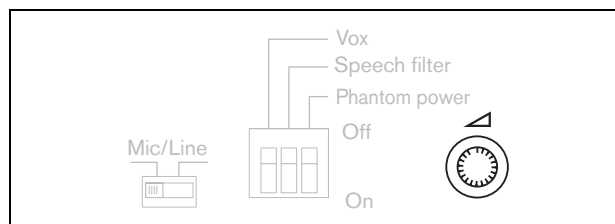

figure 19.4: VOX volume control

#### 19.1.2 Vox

If the Vox switch is in the OFF position, the input is activated when the voltage of the signal of the source is above the specified threshold. If the Vox switch is in the ON position, the input is activated when the VOX Switch trigger input is closed (see also section 5.3.9).

#### 19.1.3 Speech filter

If the Speech filter switch is in the OFF position, a speech filter is activated for the mic/line input with VOX functionality. The speech filter improves the speech intelligibility by cutting off the lower frequencies.

#### 19.1.4 Phantom power

If the Phantom power switch is in the ON position, a phantom power supply is activated. This switch only has to be put in the ON position if the source is a microphone that must receive phantom power. If the source is not a microphone or if the microphone does not accept phantom power, leave the switch in the OFF position.

## 20 Voice alarm router

### 20.1 Introduction

The voice alarm routers are configured using an ID selector and a DIP switch (see figure 20.1).

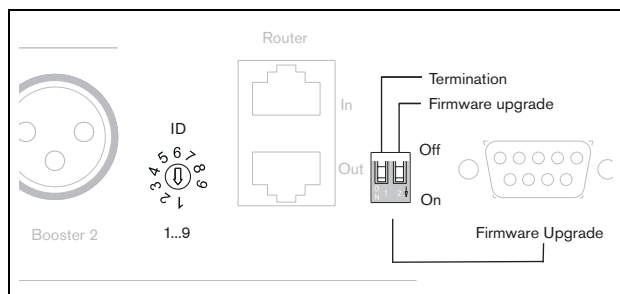

figure 20.1: Router settings

### 20.2 Router ID

The ID of the voice alarm router is set using an ID selector. Each voice alarm router must have a unique ID (1 to 9). Use a small screwdriver to turn the arrow in the correct position.

### 20.3 Termination switch

The last voice alarm router in a sequence of looped-through routers must always be terminated. Only for these voice alarm routers, put the Termination switch in the ON position.

## 21 Call station

### 21.1 Introduction

The call stations are configured using the DIP switch at the bottom (see figure 21.1).

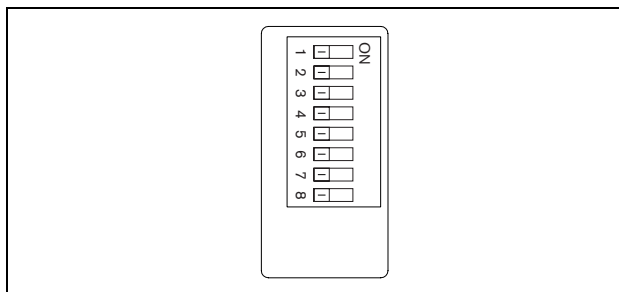

figure 21.1: Call station DIP switches

table 21.1: Call station DIP switches

DIP switch	Description
1, 2, 3, 4	Set the ID of the call station. See section 21.2
5, 6	Set the sensitivity of the call station. See section 21.3.
7	Switches the speech filter on (ON) and off (OFF). See section 21.4.
8	Switches termination on (ON) and off (OFF). See section 21.5.

### 21.2 Call station ID

The ID of the call station is set using switches 1 to 4. Each call station must have a unique ID (1 to 9).

### 21.3 Sensitivity

The sensitivity of the call station is set using switches 5 and 6 (see table 21.2).

table 21.2: Call station sensitivity

Sensitivity	Switch 5	Switch 6
-15 dB	OFF	OFF
0 dB	OFF	ON
6 dB	ON	OFF
Reserved	ON	ON

### 21.4 Speech filter

If switch 7 is in the ON position, a speech filter is activated for the call station. The speech filter improves the speech intelligibility by cutting off the lower frequencies.

### 21.5 Termination

The last call station in a sequence of looped-through call stations must always be terminated. Only for these call stations, put switch 8 in the ON position.

## 22 Remote control

### 22.1 Introduction

The remote controls are configured using a DIP switch (see figure 22.1).

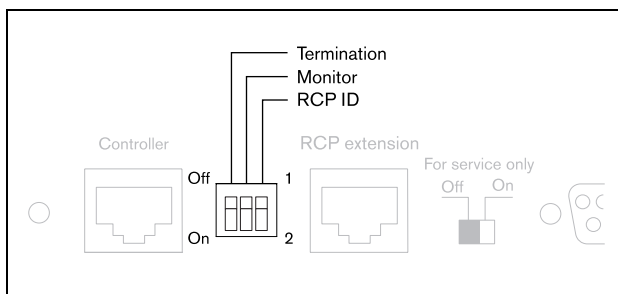

figure 22.1: Remote control settings

### 22.2 Remote control ID

The ID of the remote control is set using the RCP ID switch. The ID of the remote control must be the same as the number of the Remote Control Panel connection of the voice alarm controller to which the remote control is connected (1 to 2). Actions that are started by the remote control with ID 1 have a higher priority than actions that are started by the remote control with ID 2.

### 22.3 Monitor

If the Monitor switch is in the ON position, the internal monitoring loudspeaker of the remote control is switched on. The volume of the monitoring loudspeaker is set with the Monitoring Speaker volume control on the rear panel of the remote control.

### 22.4 Termination switch

If there are no remote control extensions connected to the remote control, the Termination switch must be in the ON position.

## 23 Remote control extension

### 23.1 Introduction

The remote control extensions are configured using an ID selector and a switch (see figure 23.1).

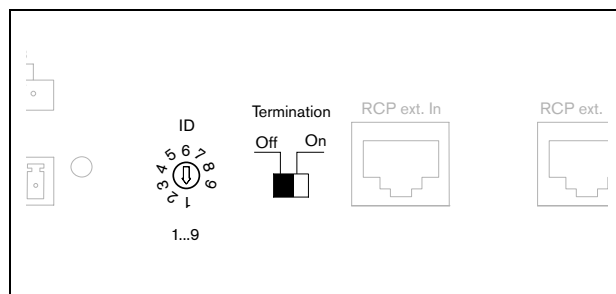

figure 23.1: Remote control settings

### 23.2 Remote control extension ID

The ID of the remote control extension is set using a ID selector. The remote control extension only controls the voice alarm router that has the same ID. Furthermore, each remote control extension that is connected to the same remote control must have a unique ID (1 to 9).

### 23.3 Termination switch

The last remote control extension in a sequence of looped-through remote control extensions must always be terminated. Only for these remote control extensions, put the Termination switch in the ON position.

Intentionally left blank.

## Section 4 - Operation

## 24 Switch on and off



### Note

It is assumed that the APR mode switch (see section 17.3) is in the OFF position.

### 24.1 Voice alarm controller

#### 24.1.1 Switch on

Put the Power switch on the rear of the voice alarm controller (see figure 24.1) in the I position.

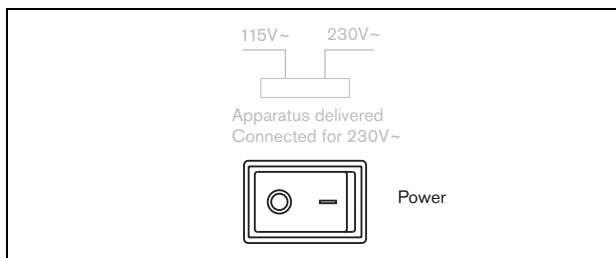

figure 24.1: Power switch

If mains power or back-up power is available, the power indicator on the front of the voice alarm controller is lit (see figure 24.2). If the system contains call stations, the power indicator of the call stations are also lit (see figure 7.1, no. 1). Furthermore, all connected remote controls and remote control extensions are switched on by the voice alarm controller.

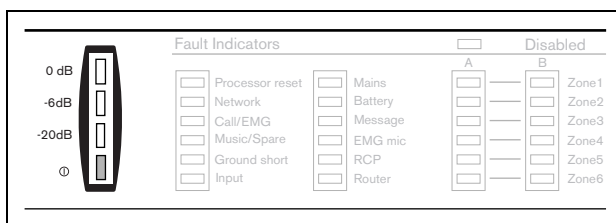

figure 24.2: Power indicator



### Note

When the system is switched on for the first time and supervision is enabled, calibrate the system (see section 24.3).

#### 24.1.2 Switch off

Put the Power switch of the voice alarm controller (see figure 24.1) in the O position.

### 24.2 Voice alarm router

#### 24.2.1 Switch on

Put the Power switch on the rear of the voice alarm router in the I position.

#### 24.2.2 Switch off

Put the Power switch of the rear of the voice alarm router in the O position.

### 24.3 Calibration

Calibration is necessary for a correct loudspeaker line impedance supervision (see section 18.11). To calibrate the system, push the calibration switch on the rear of the voice alarm controller (see figure 5.1, no. 24). The system must be calibrated:

- When the voice alarm controller is switched on for the first time.
- When a voice alarm router is switched on for the first time.
- After the connected loudspeakers are changed.
- After loudspeakers have been added.
- After the settings of the connected loudspeakers have been changed.

## 25 Background music

### 25.1 Introduction

The background music (BGM) is controlled using the BGM controls on the front of the voice alarm controller, voice alarm router and their remote control and remote control extensions. Proceed as follows to route BGM:

- 1 Select the BGM source (see section 25.2).
- 2 Select the zones (see section 25.3).

### 25.2 Select BGM source

Select the BGM source with the Select button on the front of the voice alarm controller (see figure 25.1). A green LED indicates the source that is selected.

- If the source is a CD player or a tuner that is connected to the CD/Tuner input, choose CD/Tuner.
- If the source is an auxiliary source that is connected to the Aux input, choose Aux.

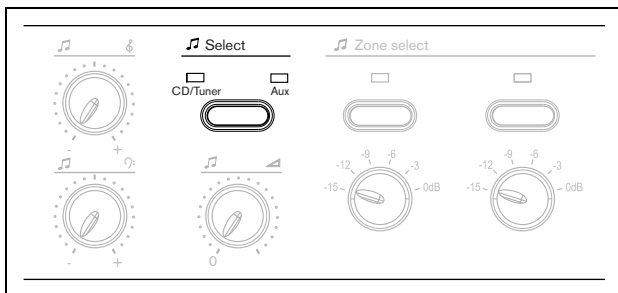

figure 25.1: BGM source selector

### 25.3 Select zones

The BGM is distributed to the zones with the Zone select buttons on the voice alarm controller (see figure 25.2), voice alarm router, remote controls and remote control extensions. A green LED indicates the zones to which BGM is distributed.

- If the Zone select indicator is off, no BGM is distributed to the zone. Push the Zone select button to distribute the BGM to the zone.
- If the Zone select indicator is on, BGM is distributed to the zone. Push the Zone select button to stop distributing the BGM to the zone.

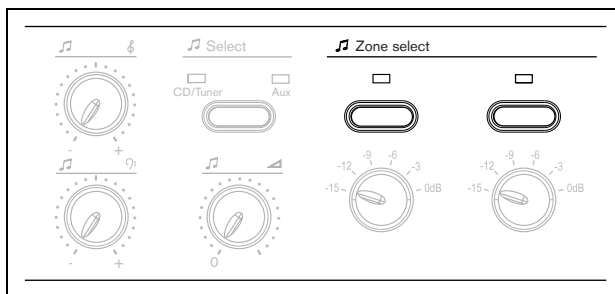

figure 25.2: BGM zone selectors

#### 25.3.1 Adjust volume

The voice alarm controller has two types of controls to adjust the BGM volume (see figure 25.3). The overall (maximum) volume of the BGM source is set with the master volume control, which is located below the BGM source selector (Select button, see figure 25.1). Per zone that is connected to the voice alarm controller, the local volume can be adjusted with the zone volume switches, which are located below the zone selection buttons (Zone select, see figure 25.2).

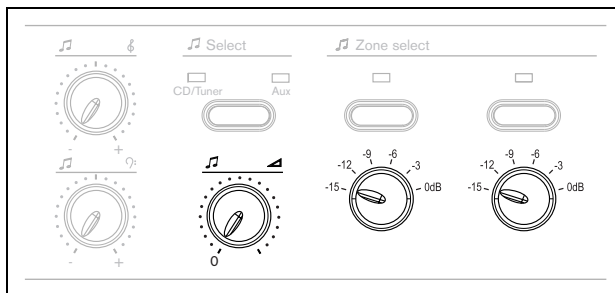

figure 25.3: BGM volume controls

The local volume in the zones that are connected to voice alarm routers must be adjusted using local volume controls.

### 25.3.2 Adjust frequencies

The voice alarm controller has two rotary knobs to adjust the sound of the BGM (see figure 25.4).

- Use the upper rotary knob to adjust the treble or high frequency content of the BGM.
- Use the lower rotary knob to adjust the bass or low frequency content of the BGM.

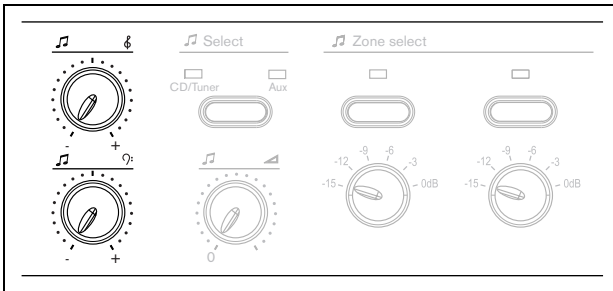

figure 25.4: BGM tone controls

## 26 Business calls

### 26.1 Introduction

Business calls can only be distributed with call stations.

It is not possible to use a hand-held emergency microphone to distribute business calls. Proceed as follows to distribute a business call:

- 1 Select the zones (see section 26.2).
- 2 Make the announcement (see section 26.2.1).

**Note**

It is also possible to distribute business calls using business trigger inputs. When an business trigger input is activated, the system automatically takes the action that is programmed with the configuration software.

**Note**

See the Configuration Software Manual (9922 141 1038x) for more information about the configuration software.

### 26.2 Select zones

Select the zones to which the business call must be distributed with the zone selection buttons on the call station or its keypads. A green LED indicates the zones to which the business call is distributed.

- If the indicator of a button is off, the zone is not selected. Push the button to select the zone.
- If the indicator of a button is on, the zone is selected. Push the button to deselect the zone.

**Note**

The zone selection buttons of the call stations and call station keypads must be configured with the configuration software.

**Note**

See the Configuration Software Manual (9922 141 1038x) for more information about the configuration software.

### 26.2.1 Make the announcement

Push the push-to-talk (PTT) button of the call station to make an announcement (see figure 26.1). The call is only distributed to the selected zones (see section 26.2).

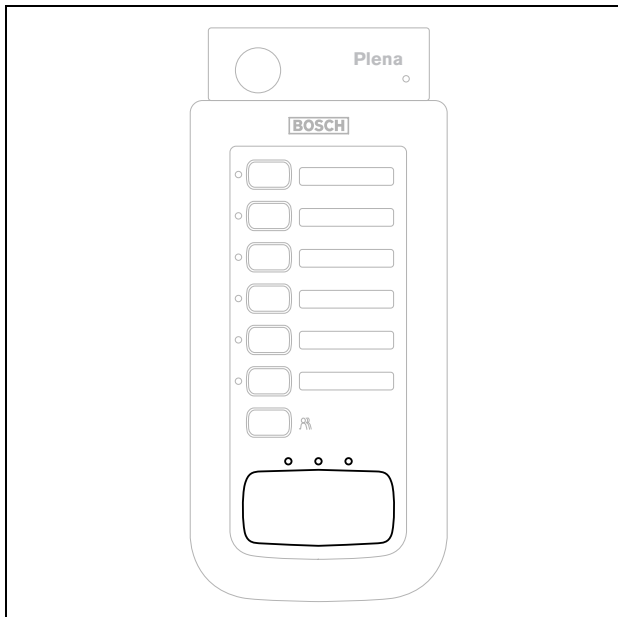

figure 26.1: PTT button and indicators

The LEDs above the PTT button provide information about the status of the call station (see table 26.1).

table 26.1: Call station status indicators

Indicator	Position	Description
Yellow	Left	Busy
Green	Center	Talk
Red	Right	System in emergency state, call station disabled.

## 27 Emergency state

### 27.1 Introduction

Emergency calls can only be distributed when the system is in the emergency state. See section 27.2 for information about entering the emergency state. In the emergency state, it is possible to distribute the following emergency calls:

- Live speech with the emergency microphone of the voice alarm controller or remote controls (see section 27.5).



**Note**

It is not possible to distribute chimes or speech with the call station when the system is in the emergency state, because the call station is disabled automatically at the moment that the system enters the emergency state.

- The default alert message (see section 27.5.4).
- The default alarm message (see section 27.5.5).



**Note**

It is also possible to distribute emergency calls using emergency trigger inputs. When an emergency trigger input is activated, the system automatically enters the emergency state and takes the action that is programmed with the configuration software.



**Note**

See the Configuration Software Manual (9922 141 1038x) for more information about the configuration software.

### 27.2 Enter the emergency state

To enter the emergency state, push the emergency button on the front of the voice alarm controller or the remote controls (see figure 27.1). The red LED that is integrated in the switch lights. The emergency state can also be entered by pushing the Emergency button on the fireman’s panel.

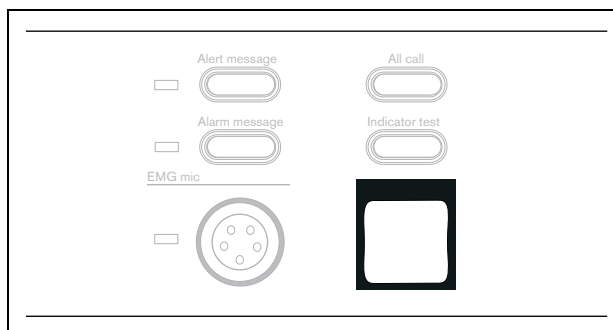

figure 27.1: Emergency button

At the moment the emergency state is entered, a beeper starts and the EMG status output contact are closed.



**Note**

See section 27.4 for information about exiting the emergency state.

### 27.3 Acknowledge the emergency state

The beeper can be switched off by acknowledging the emergency state with the EMG Ack button on the voice alarm controller and the remote controls (see figure 27.2). The beeper can also be switched off by acknowledging the emergency state with the Emergency Acknowledge button on the fireman’s panel.

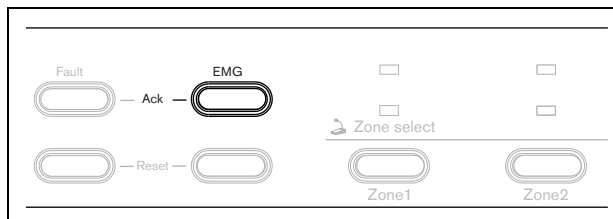

figure 27.2: EMG Ack button

## 27.4 Exit the emergency state

Exit (reset) the emergency state by pushing the EMG Reset button on the voice alarm controller and the remote controls (see figure 27.3). The emergency state can also be reset with the Emergency Reset button on the fireman’s panel. In order to reset the emergency state, it first must be acknowledged (see section 27.3).

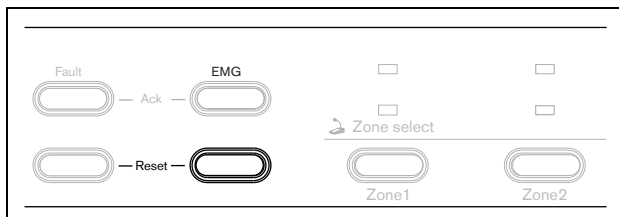

figure 27.3: EMG Reset button

## 27.5 Distribute live speech

### 27.5.1 Introduction

Proceed as follows to distribute live speech:

- 1 Select zones (see section 27.5.2).
- 2 Make announcement (see section 27.5.3).

### 27.5.2 Select zones

Select the zones to which the live speech must be distributed with the Zone select buttons on the front of the voice alarm controller or the remote controls (see figure 27.4). A red LED indicates the zones to which the live speech is distributed.

- If the indicator of a Zone select button is off, the zone is not selected. Push the button to select the zone.
- If the indicator of a Zone select button is on, the zone is selected. Push the button to deselect the zone.



#### Note

If no additional action is taken within 10 seconds after the last Zone select button has been pushed (for example closing the PTT switch), the zone selection is cancelled.

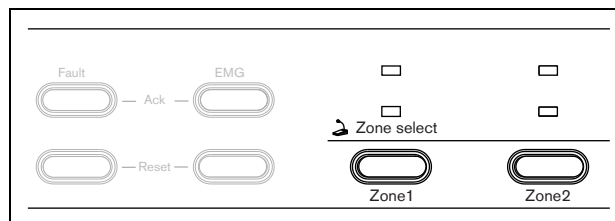

figure 27.4: Zone select buttons

To select all zones, push the All call buttons on the front of the voice alarm controller or the remote controls (see figure 27.5).

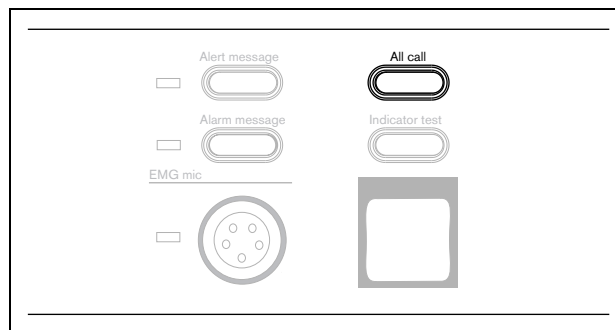

figure 27.5: All call button

### 27.5.3 Make the announcement

Push the push-to-talk (PTT) button of the emergency microphone to make an announcement (see figure 27.6). The live speech is only distributed to the selected zones (see section 26.2). At the moment the PTT button of the emergency microphone is pushed:

- The red EMG mic indicator is lit (see figure 27.7).
- If they are currently distributed, the default alert message and default alarm message are stopped.

**i Note**  
If no zones have been selected, the live speech is automatically distributed to all zones in the system.

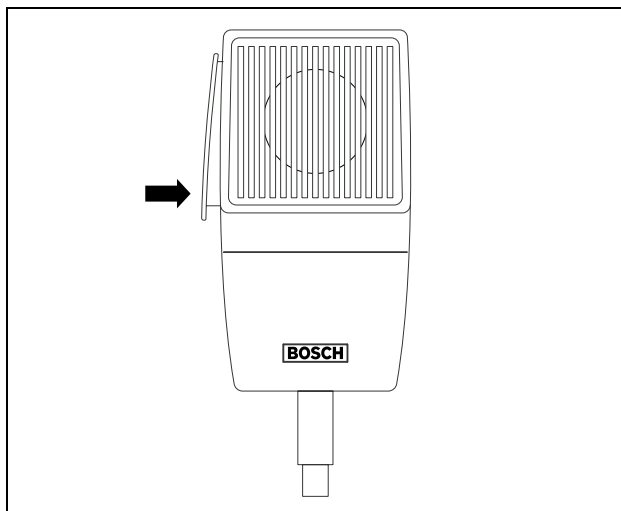

figure 27.6: Emergency microphone

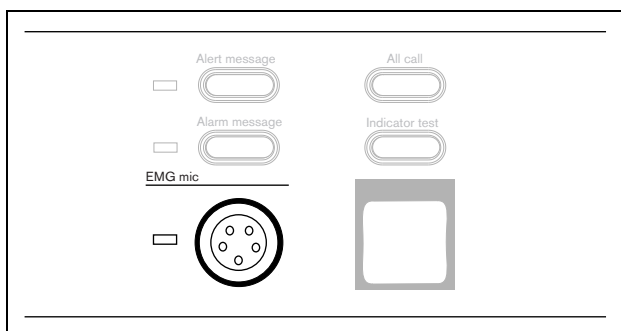

figure 27.7: Emergency microphone indicator

### 27.5.4 Distribute the alert message

#### 27.5.4.1 Introduction

Proceed as follows to distribute the default alert message:

- Select the zones (see section 27.5.4.2).
- Start the alert message (see section 27.5.4.3).

#### 27.5.4.2 Select zones

Select the zones to which the default alert message must be distributed with the Zone select buttons on the front of the voice alarm controller or the remote controls (see figure 27.4). A red LED indicates the zones to which the default alert message is distributed.

- If the indicator of a Zone select button is off, the zone is not selected. Push the button to select the zone.
- If the indicator of a Zone select button is on, the zone is selected. Push the button to deselect the zone.

**i Note**  
If no additional action is taken within 10 seconds after the last Zone select button has been pushed (for example pushing the Alert message button), the zone selection is cancelled.

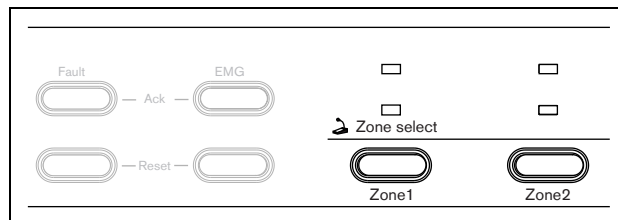

figure 27.8: Zone select buttons

To select all zones, push the All call button on the front panel of the voice alarm controller or the remote controls (see figure 27.9)

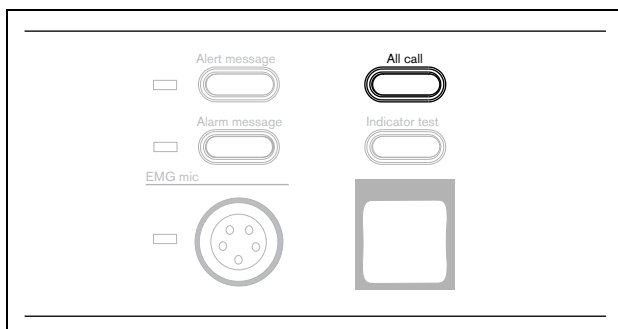

figure 27.9: All call button

### 27.5.4.3 Start the alert message

Push the Alert message button on the front of the voice alarm controller or the remote controls to distribute the the default alert message (see figure 27.10). The message is only distributed to the selected zones (see 27.5.4.2).

- If the red Alert message indicator is off, the alert message is not distributed. Push the Alert message button to distribute the default alert message.
- If the red Alert message indicator is on, the message is distributed. Push the Alert message button to stop distributing the default alert message.

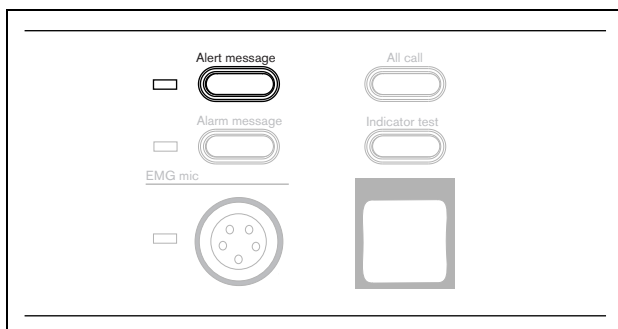

figure 27.10: Alert message button

### 27.5.5 Distribute the alarm message

Distributing the default alarm message is similar to distributing the default alert message (see section 27.5.4). Push the Alarm message button instead of the Alert message button (see figure 27.11). The alarm message can also be distributed by pushing the Alarm Message button on the fireman's panel.

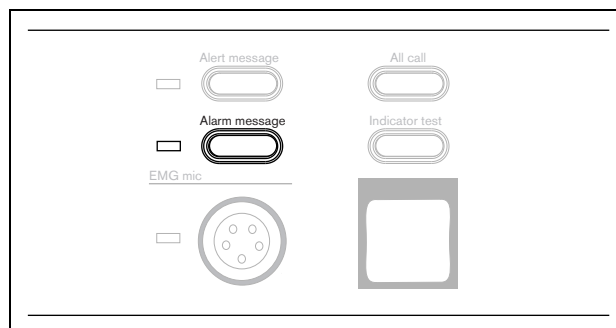

figure 27.11: Alarm message button

## 28 Fault state

### 28.1 Introduction

If a supervised function fails, the system enters the fault state and:

- Starts a beeper. The beeper is switched off when the fault is acknowledged (see section 28.2).
- Closes the Fault Status NO output contacts. These status output contact is opened again when the fault is reset (see section 28.3).
- Lights a fault indicator on the front panels that indicates the source of the fault (see section 28.4). The indicator is switched off when the fault is reset (see section 28.3).

### 28.2 Acknowledge the fault state

The beeper can be switched off by acknowledging the fault state with the Fault Ack button on the front of the voice alarm controller or the remote controls (see figure 28.1). The fault state can also be acknowledged by pushing the Fault Acknowledge button on the fireman’s panel.

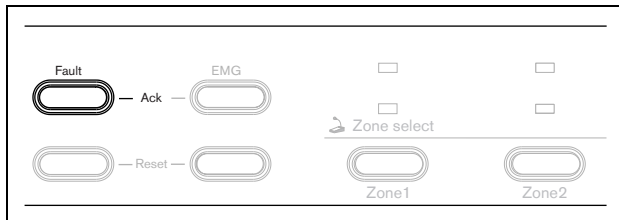

figure 28.1: Fault Ack button

The following buttons also acknowledge the fault state and stop the beeper:

- Alert button
- Alarm button
- PTT button of the emergency microphone

### 28.3 Reset the fault state

Reset the fault state by pushing the Fault Reset button on the front of the voice alarm controller or the remote controls (see figure 28.2). The fault state can also be reset by pushing the Fault Reset button on the fireman’s panel. In order to reset the fault state, it first must be acknowledged (see section 28.2). When the Fault Reset button is pushed, the fault indicators are switched off and the status of the system is checked.

- If the fault is not resolved, the fault indicators are switched on again. The beeper remains off. It is only switched on if a new fault occurs or if the resolved fault occurs again.
- If the fault is resolved, the fault indicators remain off.

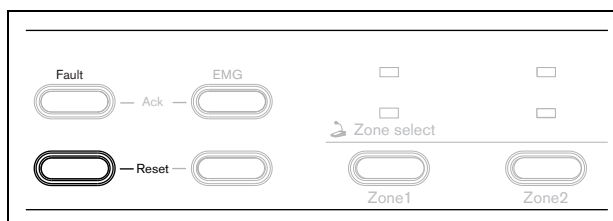

figure 28.2: Fault Reset button

### 28.4 Fault indicators

The voice alarm controller, voice alarm router and remote controls have two types of fault indicators: system fault indicators (see figure 28.3) and loudspeaker line fault indicators (see figure 28.4). The system fault indicators provide information about failing system functions that are supervised (see table 28.1). If a system fault is persistent, contact your dealer.

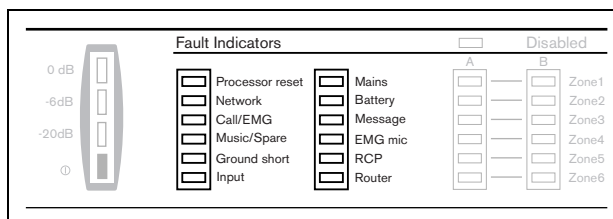

figure 28.3: System fault indicators

The loudspeaker line indicators provide information about failing loudspeaker lines. They indicate short-circuit (see section 18.11.3) and impedance supervision (see section 18.11.2) faults. If a loudspeaker line indicator lights, check the wiring of the indicated loudspeaker line and try to solve the fault. If it not possible to determine the fault, contact your dealer.

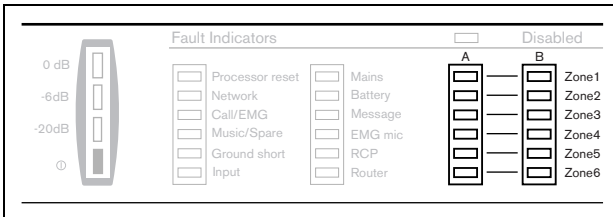

figure 28.4: Loudspeaker line indicators

If supervision is disabled (see chapter 18), the fault indicators do not function and the Disabled indicator is lit (see figure 28.5).

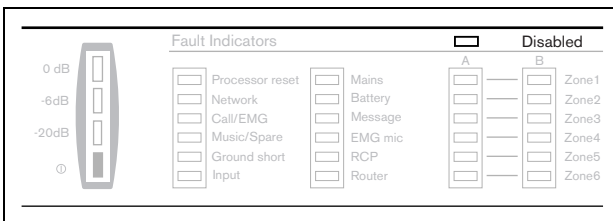

figure 28.5: Disabled indicator

The availability of the indicators can be tested with the Indicator test button (see figure 5.1, no. 11).

table 28.1: System fault indicators

Indicator	Description	Recommended action	Additional information
Processor reset	A processor reset is detected.	Switch the voice alarm controller off and on again.	See section 18.2.
Network	A network fault is detected.	Check all network connections and the network configuration.	See section 5.3.2 and chapter 20, section 5.3.3 and chapter 21
Call/EMG	The call power amplifier failed.	<u>In 1-channel mode:</u> Switch the voice alarm controller off and on again.  <u>In 2-channel mode:</u> Switch the external power amplifiers off and on again.	See section 5.3.4, section 6.3.5 and section 17.5.
Music/Spare	The BGM power amplifier failed.	<u>In 1-channel mode:</u> Switch the external power amplifiers off and on again.  <u>In 2- channel mode:</u> Switch the voice alarm controller off and on again.	See section 5.3.4, section 6.3.5 and section 17.5.
Ground short	A short-to-ground fault in the loudspeaker line cabling is detected.	Check all loudspeaker lines for short-to-ground situations.	See section 5.3.6 and section 18.11.
Input	A fault in the connection to an emergency trigger input is detected.	Check the connections to all supervised emergency trigger inputs.	See section 5.4.8 and section 18.6.
Mains	A mains power failure is detected.	Check the mains power connection of the voice alarm controller and the mains power availability.	See section 5.3.12 and section 18.7.
Battery	A back-up power failure is detected.	Check the back-up power supply connection of the voice alarm controller and the back-up power availability.	See section 5.3.12 and section 18.8.
Message	A message fault is detected.	Switch the voice alarm controller off and on again.	See section 18.9.
EMG mic	A emergency microphone fault is detected.	Check the emergency microphone. If necessary, replace it.	See section 5.3.1 and section 18.10.
RCP	A remote control panel fault is detected.	Contact your dealer.	This fault should not occur, since this type of supervision is disabled.
Router	A router fault is detected.	The indicated fault was not detected in the voice alarm controller, but in a voice alarm router.	Check the voice alarm routers.

Intentionally left blank.

## Glossary

### A

**APR mode**

Asian-Pacific Region mode.

### B

**BGM**

Background music.

**Business call**

Live announcement that is made when the system is in the normal state. Business calls can only be made with a call station.

### E

**Emergency call**

Live speech, alert message or alarm message that is distributed in the emergency state. Emergency calls can only be made with the voice alarm controller.

**Emergency state**

Emergency calls can only be distributed in the emergency state. This state is entered by pushing the red emergency button on the front panel of the voice alarm controller. At the moment the emergency state is entered, a beeper starts. Simultaneously, the default alert message and the default alarm message are distributed to all zones in the system.

### F

**Fault state**

If a supervised function fails, the system automatically enters the fault state. It starts a beeper, de-energizes the Fault Status output contact and lights an indicator on the front panel of the voice alarm controller.

### L

**LED**

Light Emitting Diode. Electronic component that frequently is used as indicator.

### P

**PC**

Personal Computer.

**PDF**

Portable Document Format. Type of file.

**Praesideo**

Digital public address and emergency sound system of Bosch Security Systems.

**PTT button**

Push-to-talk button. A button that starts the actual call.

### U

**USB**

Universal Serial Bus. Type of bus that is used to connect equipment to PCs.

### V

**VOX**

Voice-activated. The voice alarm controller has one voice-activated input to connect an additional emergency microphone or to interface with another emergency sound system (e.g. a Praesideo system).

Intentionally left blank.

## Product Index

table 28.2: Product index

Code	Reference	Description
LBB1990/00	Controller	Main unit
LBB1992/00	Router	Slave unit
LBB1994/00	Logger	Event logging unit
LBB1995/00	Fireman's panel	Remote control with basic functionality
LBB1996/00	Remote control	Remote control for controller
LBB1997/00	Remote control extension	Remote control extension for router
LBB1998/00	Remote control kit	Same as remote control, but with rugged connectors
LBB1999/00	Remote control extension kit	Same as remote control extension, but with rugged connectors
LBB1956/00	Call station	Based on existing LBB1946 with 6 zone keys and all call
LBB1957/00	Call station keypad	Call station keypad extension with 7 zone keys

Intentionally left blank.

## Emergency Sound Systems

Bosch Security Systems has made a great effort for the design and manufacturing of the components and also supplies all documentation that enables the assembly of a safe and high quality emergency unit in accordance with IEC60849. Bosch Security Systems has made up this list of requirements, based on the standard, which needs to be filled in and subsequently signed off by both parties. The signed paper has the nature of a certificate and can have significant meaning in the case of a legal investigation of the liability issue for personal injuries.

- The safety of the system in accordance with IEC60849 in an alarm and emergency application does not only depend on component safety, but also highly on the installation engineer and the operator. For example, the sound pressure level of the system depends on the installation. Moreover, the system should only be installed and operated by qualified personnel.
- Modifications of the system should only be executed by authorized persons in accordance with the safety concept and need to be registered in the system documentation.
- If third party components (not delivered by Bosch Security Systems) are added to the minimal configuration of The Plena Voice Alarm System, then the IEC60849 certification becomes expired.
- Only use a UPS compliant to the current standards and legislation in combination with the Plena Voice Alarm System.
- The end-user must maintain a journal for the system.
- The installer is responsible for security measures to prevent improper use of the system.
- Bosch Security Systems refuses any liability for damage that might result from non-observance of these instructions.

Herewith the undersigned states that he/she has processed for him/her applicable requirements, as specified in this document, in an adequate way and has confirmed this fact by signing the right most column of each applicable requirement.

### **Installer**

*Name* : \_\_\_\_\_

*Signature* : \_\_\_\_\_

*Date* : \_\_\_\_\_

*Place* : \_\_\_\_\_

### **End-user**

*Name* : \_\_\_\_\_

*Signature* : \_\_\_\_\_

*Date* : \_\_\_\_\_

*Place* : \_\_\_\_\_

## List of authorized end-users

Name : \_\_\_\_\_

Name : \_\_\_\_\_

Name : \_\_\_\_\_

Name : \_\_\_\_\_

Name : \_\_\_\_\_

Name : \_\_\_\_\_

Name : \_\_\_\_\_

Name : \_\_\_\_\_

Name : \_\_\_\_\_

Name : \_\_\_\_\_

Name : \_\_\_\_\_

Name : \_\_\_\_\_

Name : \_\_\_\_\_

Name : \_\_\_\_\_

Name : \_\_\_\_\_

Name : \_\_\_\_\_

Name : \_\_\_\_\_

Name : \_\_\_\_\_

Name : \_\_\_\_\_

Name : \_\_\_\_\_

Name : \_\_\_\_\_

Name : \_\_\_\_\_

Name : \_\_\_\_\_

Name : \_\_\_\_\_

Name : \_\_\_\_\_

Name : \_\_\_\_\_

Name : \_\_\_\_\_

Name : \_\_\_\_\_

Name : \_\_\_\_\_

Name : \_\_\_\_\_

Name : \_\_\_\_\_

Name : \_\_\_\_\_

Name : \_\_\_\_\_

Name : \_\_\_\_\_

Name : \_\_\_\_\_

Name : \_\_\_\_\_

Name : \_\_\_\_\_

Name : \_\_\_\_\_

Name : \_\_\_\_\_

Name : \_\_\_\_\_

Name : \_\_\_\_\_

Name : \_\_\_\_\_

Name : \_\_\_\_\_

Name : \_\_\_\_\_

Name : \_\_\_\_\_

Name : \_\_\_\_\_

**IEC60849 - 4. General system requirements****IEC60849 - 4.1 Principal features**

The following criteria shall be fulfilled:

*table 1: IEC60849 - 4.1 Principal features*

Requirement	Compliance	Signature
A sound system for emergency purposes shall permit the broadcasting of intelligible information of measures to be taken for the protection of lives within one or more specified areas.	Compliant, if properly installed. The relevant article is covered by the Plena Voice Alarm System, The correct installation and configuration is the responsibility of the installer.	
a When any alarm is detected, the system shall immediately disable any functions not connected with its emergency role (such as paging, music or general pre-recorded announcements being broadcast to the loudspeaker zones requiring emergency broadcasts).	Compliant. The EMG state can be entered in two ways: 1) When an emergency message is started via the EMG triggers. 2) The EMG button on the front panel, the remote control or the Fireman's panel is pressed. When the EMG state is entered, all non emergency paging and BGM is stopped	
b Unless damaged as a result of the emergency, the system shall be available for operation at all times (or as required by the system specification).	Compliant, if all requirements below are fulfilled and installed with: <ul style="list-style-type: none"> <li>• Spare Power Amplifiers.</li> <li>• Multiple loudspeaker circuits per zone or multiple zones.</li> <li>• Battery backup / UPS backup.</li> </ul> Responsibility of the installer. <ul style="list-style-type: none"> <li>• The communication bus between Controller and Routers and between Controller and Remote Controls is not redundant. If damage or removed, communication between these elements is not possible. Also, when the processor is damaged or fails the system will not function properly. In that event the fault will be clearly indicated on the Controller, Routers (if installed) and Remote Controls (if Installed) Also an audible signal is generated at the Controller and Remote Control. The installer must ensure that during downtime for repair or maintenance the safety of the occupants is ensured. Responsibility of the installer to verify that proper procedures are in place. If the processor is defective, no calls can be made. If the communication bus between routers, or between controller and remote control is broken, no call can be made beyond the point of the broken connection.</li> </ul>	
c The system shall be capable of broadcasting within 10 s after primary or secondary power is applied.	Compliant. It is recommended that the Remote Control at the fireman's entrance is programmed to have the highest priority.	
d Except during the condition described in 4.1c), the system shall be capable of broadcasting a first attention-drawing signal within 3 s of being placed in an emergency mode by the operator, or automatically on receipt of a signal from a fire or other detection system. In the latter case, the period of 3 s includes the reaction time of the detection system from the time the emergency is first detected, to commanding the alarm broadcast.	Compliant. The installer is required to ensure that the Fire detection system does not have latency beyond 2s to ensure that the entire installation reacts within 3s. Note: Reaction time of the Voice Alarm System reacts within 1 second.	

table 1: IEC60849 - 4.1 Principal features

Requirement	Compliance	Signature
e The system shall be able to broadcast attention- drawing signals and speech messages to one or more areas simultaneously. There shall be at least one appropriate attention-drawing signal alternating with one or more speech messages for this purpose.	Compliant, if attention-drawing signal is part of the configuration. Responsibility of the installer. Note: It is recommended that an attention drawing signal is assigned to the EMG button.	
f At any time the system operator shall be able to receive, by means of a monitoring system, indications of the correct functioning or otherwise of the relevant parts of the emergency system (see also 5.2 and 5.3).	Compliant.	
g Failure of a single amplifier or loudspeaker circuit shall not result in total loss of coverage in the loudspeaker zone served.  <b>NOTE 1:</b> The monitoring system (specified in 4.1f) should indicate the failure of an amplifier or of a loudspeaker circuit.  <b>NOTE 2:</b> Particularly in small buildings, it may not be necessary to install two separate loudspeaker circuits in one loudspeaker zone. A decision on this matter may be subject to local regulations.	Compliant if installed with: <ul style="list-style-type: none"> <li>• Spare Power Amplifiers.</li> <li>• Multiple loudspeaker circuits per zone or multiple zones. A-B wiring.</li> <li>• Appropriate supervision on.</li> </ul> Responsibility of the installer.	
h An attention-drawing signal shall precede the first message for 4 s to 10 s. Successive signals and messages shall then continue until either changed in accordance with the evacuation procedure, or manually silenced. The interval between successive messages shall not exceed 30 s and attention- drawing signals shall be broadcast whenever periods of silence might otherwise exceed 10 s. Where more than one attention-drawing signal is used, such as those used for different types of emergency, each signal shall be clearly distinguishable in character.	Compliant, if attention-drawing signal is part of the pre- recorded message and the configuration has been setup to include this signal. Responsibility of the installer. Note: if you deviate from this, the system is no longer a certified system.	
i All messages shall be clear, short, unambiguous and as far as practicable, pre-planned. <ul style="list-style-type: none"> <li>• Where pre-recorded messages are used they shall be held in a non-volatile form, preferably in a solid- state store, and be continuously monitored for availability.</li> <li>• The system design shall make it inherently impossible for an external source to corrupt or derange the store or its contents.</li> </ul> <b>NOTE:</b> On grounds of reliability, it is preferable not to use storage media depending on mechanical devices.	Responsibility of the installer. Default configuration is compliant. Various messages are pre installed as examples. Flash memory is monitored with checksum.  Compliant. Upload of a new configuration via external PC is password protected. Other external connections are not available.  Storage medium is flash memory card.	
j The language(s) used shall be specified by the purchaser.	Responsibility of the installer.	

*table 1: IEC60849 - 4.1 Principal features*

Requirement	Compliance	Signature
k The system shall be capable of being divided into emergency loudspeaker zones if required by the evacuation procedure. Such zones need not be the same as other zones, for example emergency detection zones or non-emergency loudspeaker zones.	Compliant, if properly installed. Responsibility of the installer.	
l In determining loudspeaker zones, the following criteria shall apply:		
1 The intelligibility of messages broadcast in one zone shall not be reduced below the requirement of 5.1 by the broadcasting of messages in other zones or from more than one source.	Compliant, if properly installed. Responsibility of the installer.	
2 No emergency detection zone shall contain more than one emergency loudspeaker zone. For non-emergency use, a loudspeaker zone may be subdivided.	Compliant, if properly installed. Responsibility of the installer.	
m A secondary power source shall be available (see 5.6).	Compliant, if properly installed. Responsibility of the installer. The system has 24V back-up power connection.	

**IEC60849 - 4.2 Responsible person***table 2: IEC60849 - 4.2 Responsible person*

Requirement	Compliance	Signature
The person or body, having control of the premises shall nominate a "responsible person", identified by name or job title, who shall be responsible for ensuring that the system is properly maintained and repaired so as to continue to operate as specified.	Responsibility of the person or body having control of the premises. Action to be taken care of by the installer.	
<b>NOTE:</b> The responsible person should be appropriately trained.		

**IEC60849 - 4.3 Priorities****IEC60849 - 4.3.1 Classification of priorities***table 3: IEC60849 - 4.3.1 Classification of priorities*

Requirement	Compliance	Signature
It is necessary to decide upon an order of priority for the message distribution based upon:	Compliant, if properly installed. Responsibility of the installer.	
a Any automatic programmed response.	Compliant, if properly installed. Responsibility of the installer. The Voice Alarm System has a priority structure.	
b The perceived risk to occupants, which may require manual override of the programmed response. Events shall be given a level of priority according to their urgency. The following primary levels are recommended but there may be advantages in adding further subgroups, depending on the operational strategies of the site:	Compliant, if properly installed. Responsibility of the installer. EMG microphone always has priority over automated messages. Compliant, if properly installed. Responsibility of the installer.	
a Evacuate - potentially life-threatening situation needing immediate evacuation.	Compliant, if properly installed. Responsibility of the installer.	
b Alert - dangerous situation nearby requiring warning of pending evacuation.	Compliant, if properly installed. Responsibility of the installer.	
c Non-emergency - operational messages, e.g. system test, etc. The use of these levels in descending order of priority will ensure that appropriate alarm signals and messages are provided first to the zones immediately at risk.	Compliant, if properly installed. Responsibility of the installer. Compliant, if properly installed. Responsibility of the installer.	

**IEC60849 - 4.3.2 Operational priorities***table 4: IEC60849 - 4.3.2 Operational priorities*

Requirement	Compliance	Signature
<p>If the voice alarm system is capable of operation in fully automatic mode, a facility shall always be available to control:</p> <p>a The type of pre-recorded message being broadcast.</p>	<p>Compliant, if properly installed:</p> <ul style="list-style-type: none"> <li>• Input contact configured to start a call with a pre-recorded message.</li> <li>• Running message can be overridden by higher priority automatic started messages.</li> <li>• Running message can be overridden by higher priority manually started messages.</li> <li>• Running messages can always be overridden by the emergency microphone</li> </ul>	
<p>b The distribution of messages to different zones.</p>	Compliant.	
<p>c Real-time instructions or information to occupants via the emergency microphone (if any).</p> <p>Means shall be provided for manual intervention to override any automatically programmed functions. This shall apply both to the nature of the message being broadcast and to the distribution paths of the message. Thus, manual controls shall be provided at the central control point (and also at specified remote control points) to allow:</p>	Compliant, if properly installed. Manual selection of loudspeaker zones is supported.	
<p>a Starting or stopping of pre-recorded alarm messages.</p>	Compliant, if properly installed. Running message can be overridden by higher priority manually started messages. Alarm and Alert messages can be stopped and started from the controller front panel.	
<p>b Selection of appropriate pre-recorded alarm messages.</p>	Compliant, if properly installed. Manual selection of pre-recorded alarm messages is supported.	
<p>c Switching on or off, of selected loudspeaker zones.</p>	Compliant, if properly installed. Manual selection of loudspeaker zones is supported. Adding or removing zones from a running call is supported.	
<p>d Broadcasting of live messages via the emergency microphone (if any).</p>	Compliant, if properly installed. Live calls from an emergency call station are supported.	
<p><b>NOTE:</b></p> <p>The above controls may form part of an emergency detection control panel.</p> <p>The emergency control microphone shall have the highest level of priority for access to the voice alarm system, with provision to allow it to override all other broadcasts.</p>	Compliant.	

## IEC60849 - 4.4 Safety requirements

*table 5: IEC60849 - 4.4 Safety requirements*

Requirement	Compliance	Signature
The safety requirements applying to emergency sound systems are given in IEC60065 or other appropriate IEC safety standards.	Compliant. The Plena Voice Alarm System complies with IEC60065.	
The mechanical construction of the system shall be such that under the influence of internally generated heat, explosion or implosion, however caused, no part shall cause injury to any person.	Compliant.	
Where any part of the system is installed in areas with hazardous or explosive atmospheres, the relevant safety requirements of IEC60079 shall be met.	Responsibility of the installer. The Plena Voice Alarm System equipment itself does not comply with IEC60079.	

## IEC60849 - 5. System technical requirements

### IEC60849 - 5.1 Speech intelligibility

*table 6: IEC60849 - 5.1 Speech intelligibility*

Requirement	Compliance	Signature
Unless otherwise specified, the following requirement shall be satisfied:		
The speech intelligibility over all of an area of coverage (see 3.1) shall be greater than or equal to 0,7 on the common intelligibility scale (CIS). See annexes A and B for the conversion between CIS and other scales of intelligibility. The noise level (see B.5) at the time of measurement (but in the absence of the test signal) and the test signal level shall be stated with the test result	Responsibility of the installer.	
NOTE - If the persons who are required to understand the messages are, or will be, reasonably familiar with them through regular system tests, the effective intelligibility tends to increase by approximately 0,05 on the CIS if the intelligibility is in the range 0,6 to 0,7. This may apply, for example, in an office building. However, in a sports ground, for example, most of the messages are likely to be relatively unfamiliar to the majority of persons present and no relaxation of the above requirement should be considered.		
The system specification may exclude from the area of coverage, defined areas rarely or never occupied by people.	Responsibility of the installer.	

**IEC60849 - 5.2 Automatic status indication***table 7: IEC60849 - 5.2 Automatic status indication*

Requirement	Compliance	Signature
A clear indication shall automatically be given at the designated control locations of:		
a System availability.	Compliant. Indication on controller, router and call station.	
b Power supply availability.	Compliant. Indication on controller, router and call station.	
c Any fault condition.	Compliant. Indication on controller, router and call station.	
d For systems having numerous loudspeaker zones, which loudspeaker zones are selected and the mode of operation of each zone, i.e. "evacuate" or "alert" and pre-selection of emergency microphone. Where different alarm messages are provided, which are dependent on the evacuation requirements, indication of which message is being broadcast and into which zone, shall be displayed by a suitable method. This information shall be continuously displayed and kept up to date.	Compliant. Indication on controller, router. The Plena Voice Alarm Remote Control is part of the certified system. If the Plena LBB1995 (FP) is used, there should only be one emergency zone, covering all zones of the system. The LBB1995 is an all call remote control with large buttons.	

**IEC60849 - 5.3 Automatic fault monitoring***table 8: IEC60849 - 5.3 Automatic fault monitoring*

Requirement	Compliance	Signature
A clear indication shall automatically be given, at specified locations, e.g. at main equipment locations, of:		
a Short-circuit or disconnection or failure of the primary power source.	Compliant, if properly installed. Responsibility of the installer. Back-up via 24 V.	
b Short-circuit or disconnection or failure of the standby power source.	Compliant, if properly installed. Responsibility of the installer. Back-up via 24 V.	
c Short-circuit or disconnection or failure of any battery charging equipment associated with the primary or standby power sources.	Responsibility of the installer. Supervision of third party charging equipment is via control inputs.	
d Rupture of any fuse or operation of circuit breaker, isolator or protective device that may prevent an emergency broadcast.	Compliant. Fault is indicated on the controller and router. Configuration must be set up to supervise this.	
e Failure of microphone, including capsule voice coil, pre-amplifier and essential wiring to the rest of the system.	Compliant. Fault is indicated on the controller and router. Configuration must be set up to supervise this.	
f Failure of critical signal paths through the amplification chain, with individual amplifiers separately identified.	Compliant. Fault is indicated on the controller and router. Configuration must be set up to supervise this.	
g Amplifiers or critical modules missing.	Compliant. Fault is indicated on the controller and router. Configuration must be set up to supervise this.	
h Failure of any standby amplifier.	Compliant. Fault is indicated on the controller and router. Configuration must be set up to supervise this.	
i Failure of emergency signal generators, including emergency pre-recorded message stores.	Compliant. Fault is indicated on the controller and router. Configuration must be set up to supervise this.	
j Failure of any loudspeaker circuit (open- and short-circuit faults).	Compliant. Fault is indicated on the controller and router. Configuration must be set up to supervise this.	

*table 8: IEC60849 - 5.3 Automatic fault monitoring*

Requirement	Compliance	Signature
k Short-circuit or disconnection of visual alarm devices.	Supervised Trigger inputs must be set up to monitor this, installer.	
l Failure of a processor to correctly execute its software program.	Compliant. Fault is indicated on the controller and router. Configuration must be set up to supervise this.	
m Detection of any error during memory checking.	Compliant. Fault is indicated on the controller and router. Configuration must be set up to supervise this.	
n Cessation of any scanning or interrogation process.	Compliant. Fault is indicated on the controller and router. Configuration must be set up to supervise this.	
<p data-bbox="172 614 632 689">o Failure of the interconnecting data or voice communication links between parts of a distributed system.</p> <p data-bbox="172 700 632 1102">In addition to individual fault identification at these locations, a common sounder shall sound for a minimum of 0,5 s every 5 s. A fault shall cause the sounder to operate in a latched mode and a visual indicator to light, either steadily, or in a flashing mode. Manual acceptance and reset switching shall be included. When accepted, the sounder shall be silenced and the indicator shall change to (or remain in) steady illumination. The occurrence of a further fault condition shall reactivate the sounder and the visual indicator. When all the faults have been cleared, the indicator shall be switched off, either automatically or by operating a reset switch.</p> <p data-bbox="172 1112 632 1238">The fault indication should be given within 100 s of the occurrence of the fault, regardless of whether the voice alarm system is being used for non- emergency purposes, such as the transmission of background music.</p>	<p data-bbox="668 614 1121 689">Compliant. Fault is indicated on the controller and router. Configuration must be set up to supervise this.</p> <p data-bbox="668 700 1121 749">Compliant. Fault identification and sounder is part of the controller.</p> <p data-bbox="668 1112 767 1132">Compliant.</p>	

**IEC60849 - 5.4 Monitoring of software controlled equipment***table 9: IEC60849 - 5.4 Monitoring of software controlled equipment*

Requirement	Compliance	Signature
<p>The correct execution of the system software by any microprocessor shall be monitored by internal self-checking procedures and by an appropriate monitoring circuit (e.g. "watch dog" circuit) complying with the following:</p>		
<p>a The monitoring circuit and its associated indication and signalling circuits shall not be prevented from determining and signalling a fault condition by the failure of any microprocessor or associated clock circuits.</p>	Compliant.	
<p>b The monitoring circuit shall monitor the execution of routines associated with the main program elements (i.e. it shall not be solely associated with "waiting" or other "housekeeping" routines).</p>	Compliant. Fault is indicated on the controller and router. Configuration must be set up to supervise this.	
<p>c In the event of a failure by a microprocessor to execute its software correctly, the monitoring circuit shall (in addition to initiating an audible and visual fault warning) perform as follows:</p>	Compliant. Fault is indicated on the controller and router. Configuration must be set up to supervise this.	
<p>1 Re-initialize the processor and attempt to restart the program at a suitable point within 10 s of the occurrence of the failure. The re-initialisation procedure shall verify that the contents of memory, both program and data, are not corrupted, and</p>	Compliant, both data and program are checked for the Controller and the firmware in the routers.	
<p>2 Either</p>		
<p>i record that a failure has occurred (using a system capable of recording a minimum of 99 failures and re-settable only by an operation restricted to authorized servicing personnel) or</p>		
<p>ii Automatically reset the equipment and give an audible and visual warning that an automatic reset has occurred.</p>	Compliant. Fault is indicated on the controller and router. This function cannot be switched off.	

**IEC60849 - 5.5 Interface with emergency detection system***table 10: IEC60849 - Interface with emergency detection system*

Requirement	Compliance	Signature
The communication link between the emergency detection system and the sound system shall be continuously monitored for faults. This is normally performed by the control equipment for the emergency detection system, which gives an audible and visual indication of a fault in the link between the two systems.	Compliant, if properly installed using supervised trigger inputs. Responsibility of the installer.	
The emergency detection system shall also be capable of receiving information regarding faults in the sound system and shall include a provision, usually at its control and indicating equipment, for appropriate audible and visual indication of such faults. As a minimum, the sound system shall be capable of transmitting to the emergency detection system one general "Sound system fault" for any of the fault conditions listed in 5.3 that may occur within the sound system.	Compliant, if properly installed using trigger outputs. Responsibility of the installer.	
The link between a fire detection and alarm system and the voice alarm system is of crucial importance in maintaining the integrity of overall operation. It may be desirable on larger systems, where distributed control equipment is used, to provide a link at each control equipment location rather than to rely on a central location. Each link shall be monitored. The voice alarm system shall be capable of continuing to broadcast alarm messages, which have been initiated by the fire detection and alarm system, even in the event of a subsequent fault in the interconnecting link between the two systems (i.e. the voice alarm system shall "latch" on receipt of a signal from the fire detection and alarm system). Interruption by higher priority broadcasts shall still be possible.	N/a	
In complex buildings in which actions, such as initiation of evacuation signals, silencing of alarm signals, etc., can be implemented at remote voice alarm equipment, consideration shall be given to whether there is a need for such actions to be indicated at any central fire detection and alarm control and indicating equipment.	Responsibility of the installer.	

**IEC60849 - 5.6 Secondary power supply***table 11: IEC60849 - 5.4 Secondary power supply*

Requirement	Compliance	Signature
<p>If the building is to be evacuated following primary power failure, a secondary power supply shall be provided. This shall be capable of operating the system in the emergency mode for a period equal to twice the evacuation time determined by the appropriate authority for the building. In any event, the secondary power supply shall be capable of powering the system for a minimum of 30 min.</p>	<p>Power consumption data is available in various Plena equipment data sheets. With this information the necessary back up capacity can be calculated, Responsibility of the installer.</p>	
<p>If the building is not to be evacuated following failure of the principal power supply, the secondary power supply shall be capable of operating the system for at least 24 h, or 6 h if an emergency generator is available, and then powering the system in emergency mode for a minimum of 30 min. If a building remains unoccupied for several days, provision should be made to ensure that the voice alarm system is capable of operation in emergency mode for 30 min when the building is re-occupied.</p>	<p>See above. Responsibility of the installer.</p>	
<p>Non-emergency functions within the system, such as background music, shall not operate from the secondary power supply if this will reduce the capacity for emergency operation.</p>	<p>Responsibility of the installer by connecting the BGM source to the primary power supply. From release 1.1 onwards the BGM will be deactivated.</p>	
<p>If batteries are used as a secondary power supply they shall be of the secondary type, complete with automatic charging facilities. Where lead-acid batteries are used they shall be of the valve-regulated type unless otherwise specified, and the charging system shall incorporate charging current compensation for changes in the ambient temperature, where this is necessary to achieve the specified battery life.</p>	<p>Responsibility of the installer.</p>	
<p>Batteries shall be used in accordance with the manufacturer's recommendations in order to achieve their specified life, which shall be not less than four years. The end of life shall be taken as the time when deterioration to less than 80% of the rated ampere- hour capacity (at the one-hour rate) has occurred.</p>	<p>Responsibility of the installer.</p>	
<p>Automatic charging shall ensure that the batteries are fully recharged to 80% of their maximum rated capacity from the fully discharged state in a period of not more than 24 h.</p>	<p>Responsibility of the installer.</p>	
<p>Adequate ventilation and protection against corrosion and dangers resulting from gases emitted by the batteries shall be provided.</p>	<p>Responsibility of the installer.</p>	

**IEC60849 - 5.7 Climate and environmental conditions***table 12: IEC60849 - 5.7 Climate and environmental conditions*

Requirement	Compliance	Signature
<p>As all or part of the system may be installed inside or outside buildings, under various climatic and environmental conditions, and exposed to possible mechanical damage, full information on the conditions under which the system is required to operate shall be included in the system specification. For tests, refer to IEC60068-1 (environmental testing).</p> <p>When not otherwise specified, equipment shall operate in accordance with the system specification under the following conditions:</p> <p>a Control and amplification equipment and associated battery power supplies:</p> <ul style="list-style-type: none"> <li>• Ambient temperature -5 °C to + 40 °C</li> <li>• Relative humidity 25% to 90%.</li> <li>• Air pressure 86 kPa to 106 kPa.</li> </ul> <p>b All other equipment:</p> <ul style="list-style-type: none"> <li>• Ambient temperature -20 °C to +55 °C.</li> <li>• Relative humidity 25% to 99%.</li> <li>• Air pressure 86 kPa to 106 kPa.</li> </ul>	<p>The Plena Voice Alarm System specifications exceed the environmental requirements given by IEC60849.</p> <p>Responsibility of the installer by connecting the BGM source to the primary power supply. From release 1.1 onwards the BGM will be deactivated.</p>	

**IEC60849 - 5.8 Marking and symbols for marking***table 13: IEC60849 - 5.8 Marking and symbols for marking*

Requirement	Compliance	Signature
Equipment shall be permanently marked with information regarding its function.	Compliant.	
Terminals and controls shall be permanently marked with information regarding their function, characteristics and polarity.	Compliant.	
The marking shall be such that it shall be possible to adjust the user controls and to confirm their positions accurately in conformity with the information given in the user instructions.	Compliant.	
Marking shall preferably include letter symbols, signs, numbers and colors that are internationally comprehensible. Reference is required to IEC60027 and IEC60417. Marking not included in these standards shall be clearly explained in the user instructions.	Compliant.	

**IEC60849 - 5.9 Electrical matching values***table 14: IEC60849 - 5.9 Electrical matching values*

Requirement	Compliance	Signature
For the electrical matching values, reference is required to IEC61938 unless otherwise specified.	Compliant (specified in Technical data sections).	

**IEC60849 - 5.10 Connectors***table 15: IEC60849 - 5.10 Connectors*

Requirement	Compliance	Signature
Connectors shall comply with IEC60268-11 or IEC60268-12. Requirements for fire resistance of connectors may also be stipulated by the relevant authorities.	Connectors comply with IEC60268-11 or IEC60268-12. Additional requirements are the responsibility of the installer, i.e. cables wiring and loudspeakers should comply with IEC60849. Responsibility of the installer.	

**IEC60849 - 6. Installation requirements***table 16: IEC60849 - 6. Installation requirements*

Requirement	Compliance	Signature
The system shall be installed in accordance with IEC60364 or with mandatory national or local standards.	Responsibility of the installer.	
If the emergency sound system forms part of an emergency detection and/or alarm system, the cabling shall meet the requirements of mandatory national or local, emergency and/or alarm system standards. Where the application specifically excludes detection and/or alarm, the cabling shall be of a standard suitable for the application.	Responsibility of the installer.	
Precautions shall be taken to prevent the spread of hazardous effects via the wiring routes.	Responsibility of the installer.	
When a sound system for emergency purposes is installed in combination with an emergency detection system, the installation standards for the sound system shall comply as far as is applicable with the standards required for that detection system.	Responsibility of the installer.	
When additions and/or modifications are made to a non-compliant system the existing system may require to be upgraded to meet this standard. In all cases the additions and/or modifications shall meet this standard.	Responsibility of the installer.	

**IEC60849 - 7. Instructions for use****IEC60849 - 7.1 Instructions for operation***table 17: IEC60849 - 7.1 Instructions for operation*

Requirement	Compliance	Signature
<p>Instructions for the operation of the system, including actions to be taken in accordance with established and well-rehearsed procedures, shall be available for rapid reference, preferably prominently and permanently displayed, at each control station.</p>	Responsibility of the installer.	
<p>As far as possible, graphic illustrations should be used: where text is necessary this should be clearly legible and in the preferred language(s).</p>	Compliant. Availability of user instructions is the responsibility of the installer.	
<p>Updating of the instructions for operation shall be carried out after additions to or modifications of the system, or on the basis of practical experience, or revised procedures.</p>	Responsibility of the installer.	
<p>Instructions shall include:</p> <ul style="list-style-type: none"> <li>• The functional operation of the system.</li> <li>• Action to be taken in the event of a system failure.</li> </ul>	Responsibility of the installer.	
<p>A bound copy of the operational instructions shall be provided.</p>	Compliant. A printed version of the English User Manual is provided and electronic copies in Dutch, French, German, Polish, Norwegian, Finnish, Swedish, Portuguese, and Spanish. The Installation and User Instruction are available electronically in English. Responsibility of the installer.	

**IEC60849 - 7.2 Records to be kept***table 18: IEC60849 - 7.2 Records to be kept*

Requirement	Compliance	Signature
Installation, logbook and maintenance records shall be kept by the end-user and/or maintenance company contracted by the end-user in accordance with relevant international and national standards. These shall comprise as a minimum:	Responsibility of the installer.	
a Installation	Responsibility of the installer.	
1 Details of the locations of all items of the equipment.	Responsibility of the installer.	
2 "as installed" performance measurements of the system including:	Responsibility of the installer.	
• Measured loudspeaker loading per circuit in emergency mode.	Responsibility of the installer.	
• Settings of any adjustable items within the system, including the output level of power amplifiers.	Responsibility of the installer.	
• Sound pressure levels.	Responsibility of the installer.	
• Intelligibility measurements.	Responsibility of the installer.	
b Log book. A stiff covered log book shall be kept, in which all usage of the system and all fault occurrences should be recorded, together with all available automatically produced records, to include:	Responsibility of the person nominated by the person or body, having control of the premises (see 4.2).	
1 Dates and times of usage of the system.		
2 Details of tests and routine checks carried out.		
3 Time and date of each fault occurrence.		
4 Details of the fault found and the circumstances of it being found (for example during routine maintenance).		
5 Action taken to rectify or remedy.		
6 Date, time and name of person in charge of the system.		
7 Countersignature of the responsible person, if any faults occurred or have been rectified.		

**IEC60849 - 7.3 Maintenance****IEC60849 - 7.3.1. General***table 19: IEC60849 - 7.3.1 General*

Requirement	Compliance	Signature
There shall be an established and documented procedure for the scheduled maintenance and retesting of the sound system and equipment as recommended by the system designer in conjunction with the equipment manufacturer and in accordance with relevant international and national standards. It is recommended that a minimum of two scheduled maintenance inspections, by a competent person, be made each year. A responsible person (see 4.2) shall be nominated to ensure that the procedure continues to be carried out correctly.	Responsibility of the installer to establish the maintenance procedures using the manufacturer documentation.	

**IEC60849 - 7.3.2 Maintenance instructions***table 20: IEC60849 - 7.3.2 Maintenance instructions*

Requirement	Compliance	Signature
A stiff-covered maintenance manual should be available giving details of all work required to maintain the installation and equipment in proper working order, consistent with specified performance criteria and any other requirements of this standard and other relevant international or national standards. This should state clearly:	Responsibility of the installer to establish the maintenance procedures using the manufacturer documentation.	
a The method of maintenance.		
b Any sequence related to maintenance.		
c Identification of parts requiring maintenance, giving reference to the location of items on drawings, together with manufacturer's reference numbers, and the addresses, telephone and facsimile numbers, of suppliers of materials and parts.	Preventive Maintenance: Vacuum cleaning of the LBB1990 and the external power amplifier(s) every +/- 2 years (depending on the ambient dust) When used, vacuum clean the rack mounting filters of the cooling fans +/- 2 years (depending on the ambient dust) Prevent or remove animal nests (mice and rats can eat the cabling).	
d Original versions of equipment and materials catalogues.	Compliant. For this purpose retain the original data sheets and IUI.	
e List and location of spare parts.	Responsibility of the installer.	
f List and location of special tools.	N/a	
The maintenance instructions should also include:		
a Test certificates as required to be examined by the relevant authority.	Responsibility of the installer.	
b A set of "as fitted" drawings.	Responsibility of the installer.	

**IEC60849 - When using the Plena Remote Control Kits:**

The Plena Remote Control Kit LBB1997 and the Plena Remote Control Extension Kit LBB1998 are versions of the Remote Control LBB1996 and Remote Control Extension LBB1997 with connector interfaces in stead of LED and buttons. These kits enable the use to built custom panels for the Voice alarm System. Functionality and firmware is identical to the remote control (extension). The compliancy to IEC60849 is valid as long as the buttons and LED's/

lamps are connected correctly. This should be done by a qualified electrician. Furthermore the final installation should always be tested according to the above standard to ensure proper functioning.

When installing in a 19" rack please ensure the following:

- Ventilation requirements are met and ambient temperature inside rack is below 55 degrees
- Indications are visible from the outside
- The sounder is audible
- Access level control is met if applicable
- The rack is properly grounded.

This page is intentionally left blank.



© Bosch Security Systems B.V.  
Data subject to change without notice  
2006-06 | 9922 141 10377 en

**BOSCH**